

HAMEG

Instruments

MANUAL

Oscilloscope HM408

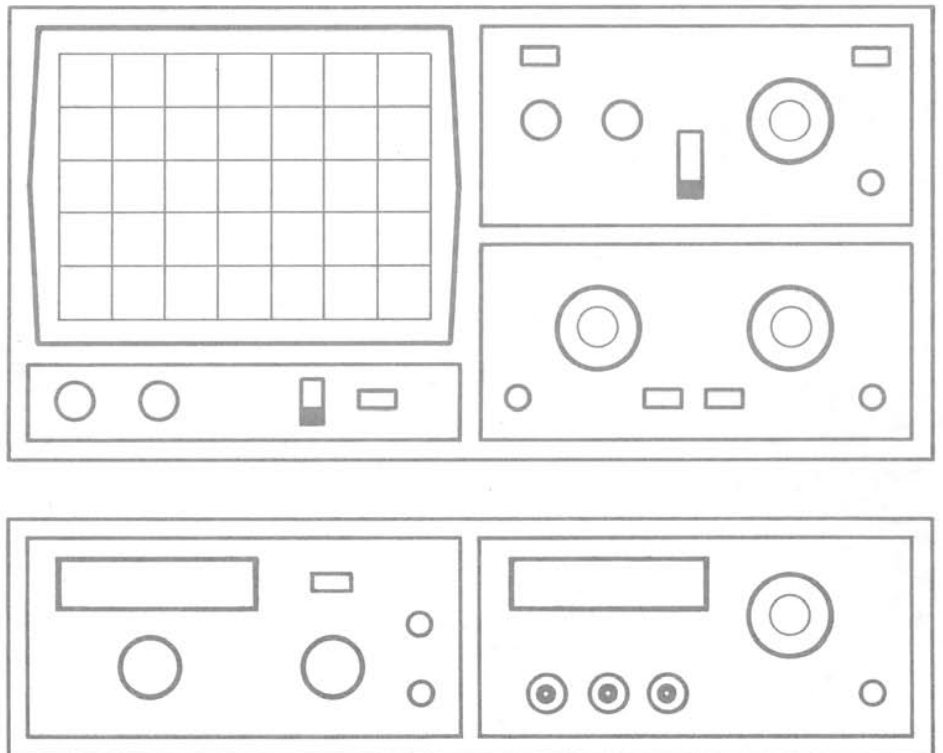

Oscilloscope datasheet with technical details P 1

Operating Instructions

General Information M 1
 Use of tilt handle M 1
 Safety M 1
 Operating conditions M 2
 Guarantee M 2
 Maintenance M 2
 Power supply M 2
 Type of the signal voltage M 3
 Amplitude Measurement M 3
 Reference Line M 4
 Time Measurements M 4
 Connection of Test Signal M 6
 First Time Operation M 7
 Trace Rotation M 7
 Use and compensation of probes M 8
 1 kHz compensation M 8
 1 MHz compensation M 8
 Operating modes of the vertical amplifiers M 9
 X-Y Operation M10
 Phase difference measurement in DUAL mode M11
 Measurement of an amplitude modulation M11
 Triggering and time base M12
 Automatic Triggering M12
 Normal Triggering M12
 Slope M12
 Trigger coupling M13
 Line Triggering M13
 Triggering of video signals M13
 External Triggering M14
 Trigger Indicator M14
 Holdoff-time adjustment M14
 Y Overscanning Indication M15
 Scale Illumination M15

Readout M16-18

Storage Operation

Controls and indicators of the storage section and their functions M19-23
 Storage resolution and operating modes M23
 HAMEG interface M24
 Safety note M24

Short instruction

Front panel elements K 1,
 Folder with front view K 2

Test Instructions

General T 1
 Cathode-Ray Tube: Brightness and Focus, Linearity, Raster Distortions T 1
 Astigmatism Check T 1
 Symmetry and Drift of the Vertical Amplifier T 1
 Transmission Performance (Vertical Amplifier) T 1
 Operating Modes: CHI/II, DUAL, ADD, CHOP., INVERT and X-Y Operation T 2
 Triggering Checks T 2
 Timebase T 3
 Trace Alignment T 3

Important!

Please be sure to read the safety information on pages M1 and M24 before using this oscilloscope!

Oscilloscope HM408 E

Service Instructions

General remarks S 1
 Safety notes S 1
 Instrument Case Removal S 1
 Operating Voltages S 1

Block Diagram analogous, digital D 1 - D 2

Circuit Diagrams analogous D 3 - D19
 digital D20 - D26

Component Locations D27 - D36

Block Diagram, Timing Diagram BUS D37 - D38

Adjustment Points D39 - D40

Specification

Vertical Deflection

Operating modes: Channel I or Channel II separate, Channel I and II; altern. or chop. (Frequ. 0.5MHz)
Sum or difference from Ch. I and Ch. II, (Ch. II invert.)
XY-Mode: via Channel II and Channel I.
Frequency range (analog): DC - 40MHz (-3dB). Risettime: approx. 8.75ns. Overshoot: $\leq 1\%$.
Frequency range (digital): DC - 2MHz (at min. 20 points per curve).
Deflection coefficients: 10 calibrated positions from 5mV/div to 5V/div in 1-2-5 sequence $\pm 3\%$, variable 2.5:1 to min. 12.5V/div.
Y-expansion x5 (calibrated) to **1mV/div $\pm 5\%$** in the frequency range from DC-5MHz (-3dB).
Input impedance: 1M Ω II 25pF.
 Input coupling: DC-AC-GND.
 Input voltage: max. 400V (DC + peak AC).
Delay line: approx. 90ns

Triggering

With Automatic: **10Hz - 80MHz** (≥ 5 div height), normal with level control: **DC - 80MHz**.
 Slope: positive or negative.
 LED indicator on passing the trigger point.
 Source: Channel I, Channel II, line, external.
 Coupling: **AC** (≥ 10 Hz - 20MHz), **DC** (0 - 20MHz), **LF** (0 - ≤ 1 kHz), **HF** (≥ 15 kHz - 80MHz).
Trigger level external ≥ 200 mV.
TV-Sync-Separator for frame and line.

Horizontal Deflection

Time coefficients (analog): 23 calibr. steps from 50ns to 1s/div in 1-2-5 sequence, $\pm 3\%$, variable 2.5:1 to min. 2.5s/div, with **X-expansion x10** to 5ns/div ($\pm 5\%$).
Time coefficients (digital): 21 calibr. steps from 10 μ s - 50ms/div and 0.1s - 50s/div $\pm 3\%$,
Bandwidth X-amplifier: 0 - 2.5MHz (-3dB)
 Input X-amplifier via Channel II,
 Sensitivity see Channel II.
X-Y-phase shift: $< 3^\circ$ below 120kHz.

Digital Storage

Operating modes: Roll, Refresh, Single, XY-Mode, Hold Ch. I, Hold Ch. II, Dot Joiner.
Sampling rate: Mono Ch. I or Ch. II max. **40MS/s**, Dual and XY-mode 2x20MS/s.
Memory: 2kx8 bit per channel, single mode 4kx8 bit.
Pre-Trigger: 25-50-75-100%.
Resolution X: 400 points/div or 2x200 points/div
Y: 25 points/div
XY: 2x2kx8 bit = display X 8 bit, Y 8 bit.
 Memory back-up by 2 AA-type batteries (option).
 Input for external timebase clock.
XY/Yt-Recorder output: Y 0.1V/div, X 0.1V/div ($\pm 2\%$); Output impedance: < 1 k Ω .
 Writing speed selectable in 4 steps.
 Penlift: TTL and CMOS compatible (open collector).
 Terminal for HAMEG Graphic Printer.
Option: External IEEE-Bus Interface (**HO79-2**).

Readout (analog/digital)

Readout storage: Y 2kx8 bit, X 2kx12 bit.
 Display of X- and Y-deflection coefficients.
 Pretrigger value (digital mode only).
Cursor X or Y with display for ΔU , Δt or f.
 Triggerlevel indication. Readout disconnectible.
 Readout intensity separately adjustable.

General Information

CRT: E8369B31, **8x10cm**, approx. 14kV.
 Rectangular screen, internal graticule, quick-heating.
 Graticule illumination.
 Trace rotation: adjustable on front panel.
Calibrator: ≈ 1 kHz/1MHz; 0.2 ($t_r \approx 5$ ns)/2V $\pm 1\%$.
Protective system: Safety Class I (IEC 348).
 Line voltages: 100...240V $\sim \pm 10\%$.
Power consumption: ≈ 43 Watt, 50...400Hz.
 Max. ambient temperature: -10°C ... $+40^\circ\text{C}$.
 Weight: approx. 8kg. Colour: techno-brown.
 Cabinet (mm): **W 285, H 145, D 380**.

Subject to change without notice

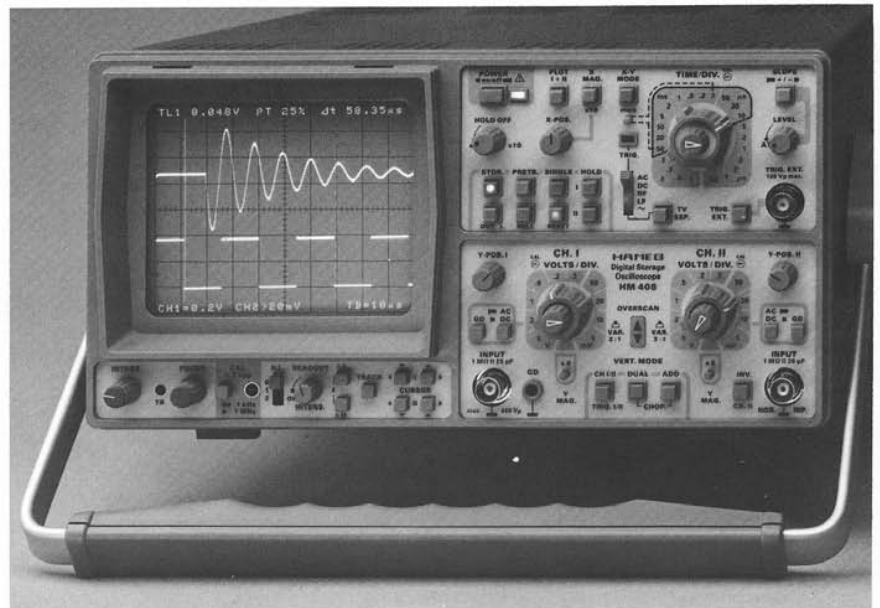

Digital Storage Oscilloscope

Analog: 2 Channels DC - 40MHz, max. 1mV/div., CRT with 14kV, Timebase 2.5s - 5ns/div., Trigger DC - 80MHz.

Digital: Max. sampling rate 40MHz, Memory 4x 1024x8 bit, Timebase 50s - 1 μ s/div., Pre-Trigger, XY Mode.

With the introduction of the new **HM408** Dual Channel **Digital Storage Oscilloscope**, HAMEG, is once again setting an unprecedented standard for highest performance at lowest cost. The user-friendly design combines easy and convenient operation with a wide variety of analog and digital functions. **40MHz maximum sampling rate** provide excellent response to input signals ranging from extremely low frequencies (in the Millihertz range) to several Megahertz. For example, a 2MHz signal can be displayed with 20 sampling points resolution per cycle.

A "dot-joiner" can be used to improve the visual appearance of signals displayed with expanded time resolution. With its **refresh-, single-, roll-, and X/Y-mode**, the **HM408** provides all the essential functions to meet today's waveform acquisition requirements. Hold pushbuttons for both channels allow the operator to "freeze" the memory contents and prevent them from being overwritten. During single channel operation the **2kB storage memory** of the idle channel can be used either to store a reference signal, or to increase the trace resolution to **4kB**. An optional built-in battery ensures that stored signals can be retained in memory for several months without power.

Another convenient feature is the **HM408's** fully selectable **pretrigger**, used to store and display waveform history preceding the actual trigger event. On-screen alphanumeric **readout** and **cursor functions** provide outstanding operating convenience. The **HM408** can also be used as a **40MHz analog oscilloscope** with such advanced features as **14kV** cathode ray tube, **Delay line**, graticule illumination, **overscan indication**, and a **1kHz / 1MHz square wave calibrator**.

For integration into automated test systems, the **HM408** can be extended with an optional **IEEE-Interface, HO79-2**. An extensive **software package** is included with this option. This software is designed to enhance signal data acquisition with the **HM408** and **PC/XT/AT** compatible **computers**. Instant hardcopies can be obtained through the **HAMEG HM8148-2** Graphic Printer.

Accessories supplied

Two 10:1 wideband probes, Line cord, Operators Manual

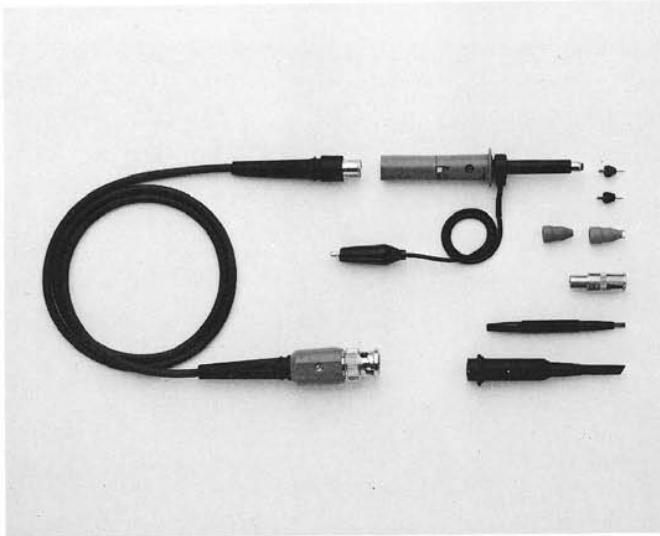

Modular Probes

The clear advantage over ordinary probes are field replaceable parts and the HF-compensation feature on the 10:1 attenuator probes. For the first time, probes in this price range allow adjustments of their HF-characteristics to match individually the input impedance of each scope. This is particularly important for scopes with higher bandwidths (>50MHz), as otherwise strong overshoot or rounding may occur, when measuring fast-rising square waves. An exact HF-compensation, however, is only possible with square-wave generators having a risetime <5ns. Most HAMEG scopes already feature such a calibration generator. For other oscilloscopes, it is available as accessory item HZ60-2. At present the following Modular Probes are available (HZ36 without HF-compensation):

Type	HZ36 selectable	HZ51	HZ52	HZ53	HZ54 selectable
Attenuation Ratio	1:1/10:1	10:1	10:1 (HF)	100:1	1:1/10:1
Bandwidth min. (MHz)	10/ 100	150	250	150	10 / 150
Risetime (ns)	35/3.5	<2	<1.4	<2	35/<2
Inp. Capacitance (pF)	47/18	16	16	6,5	40/18
Inp. Resistance (MΩ)	1/10	10	10	100	1/10
Inp. Voltage max. (V _p)	600	600	600	1200	600
Cable Length (m)	1.5	1.2	1.5	1.5	1.2

Spare Cable for HZ36

HZ39

Spare Cable for HZ51, HZ54

HZ57

Sparepart Kit (2 sprung hooks, 2 screw tips, 1 ground cable)

HZ40

Demodulator Probe

HZ55

Special probe for AM-demodulation and wobulator measurements. HF-Bandwidth 100kHz - 500MHz (±1dB). AC Input Voltage 250mV - 50V_{rms}. DC Isolation Voltage 200V DC including peak AC. Cable length 1.2m.

High Voltage Probe

HZ58

For measurement of voltages up to 15kV_{pp}. Input resistance approx. 500mΩ. Recommended load resistance 1MΩ/10MΩ (switchable). Attenuation ratio 1000:1. Bandwidth 1MHz. Cable length 1.5m. BNC connector.

Test Cable Banana - BNC

HZ32

Coaxial test cable; length 1.15m, characteristic impedance 50Ω. Cable capacitance 120pF. Input voltage max. 500V_p.

Test Cable BNC - BNC

HZ34

Coaxial test cable; length 1m, characteristic impedance 50Ω. Cable capacitance 126pF. Input voltage max. 500V_p.

Adapter Banana - BNC

HZ20

Two 4mm binding posts (19mm between centers) to standard BNC male plug. Input voltage max. 500V_p.

50Ω Through-Termination

HZ22

For terminating systems with 50Ω characteristic impedance. Maximum load 2W. Max. voltage 10V_{rms}.

Carrying Cases

For HM 103

HZ95

For HM203, HM204, HM205, HM208, HM408, HM604, HM605 and HM1005

HZ96

Viewing Hood

HZ47

For HM203, HM204, HM205, HM208, HM408, HM604, HM605 and HM1005

Scope-Tester

HZ60-2

For Checking the Y amplifier, timebase, and compensation of all probes, the HZ60-2 is a crystal-controlled, fast rising (typ. 3ns) square-wave generator with switchable frequencies of DC, 1-10-100Hz, 1-10-100kHz, and 1MHz. Three BNC outputs provide signals of 25mV_{pp} into 50Ω, 0.25V_{pp} and 2.5V_{pp} (open circuit for 10x and 100x probes); accuracy ±1%. Battery-powered.

Component-Tester

HZ65

Indispensable for trouble-shooting in electronic circuits. Single component and in-circuit tests are both possible. The HZ65 operates with all scopes, which can be switched to X-Y operation (ext. horizontal deflection). Non-destructive tests can be carried out on almost all semiconductors, resistors, capacitors, and coils. Two sockets provide for quick testing of the 3 junction areas in any small power transistor. Other components are connected by using 2 banana jacks. Test leads supplied.

Examples of Test Displays:

Short circuit

Capacitor 33μF

Junction E-C

Z-Diode <8V

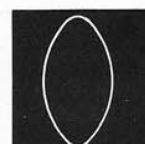
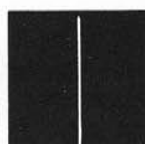

Operating Instructions

General Information

The HM408 is the combination of an analog (real time) 20MHz oscilloscope with a digital storage oscilloscope for slow-speed phenomena.

This oscilloscope is easy to operate. The logical arrangement of the controls allows anyone to become familiar with the operation of the instrument after a short time, however, experienced users are also advised to read through these instructions so that all functions are understood.

Immediately after unpacking, the instrument should be checked for mechanical damage and loose parts in the interior. If there is transport damage, the supplier must be informed immediately. The instrument must then not be put into operation.

Use of tilt handle

To view the screen from the best angle, there are three different positions (C, D, E) for setting up the instrument. If the instrument is set down on the floor after being carried, the handle remains automatically in the upright carrying position (A).

In order to place the instrument onto a horizontal surface, the handle should be turned to the upper side of the oscilloscope (C). For the D position (10° inclination), the handle should be turned in the opposite direction out of the carrying position until it locks in place automatically underneath the instrument. For the E position (20° inclination), the handle should be pulled to release it from the D position and swing backwards until it locks once more.

The handle may also be set to a position for horizontal carrying by turning it to the upper side to lock in the B position. At the same time, the instrument must be moved upwards, because otherwise the handle will jump back.

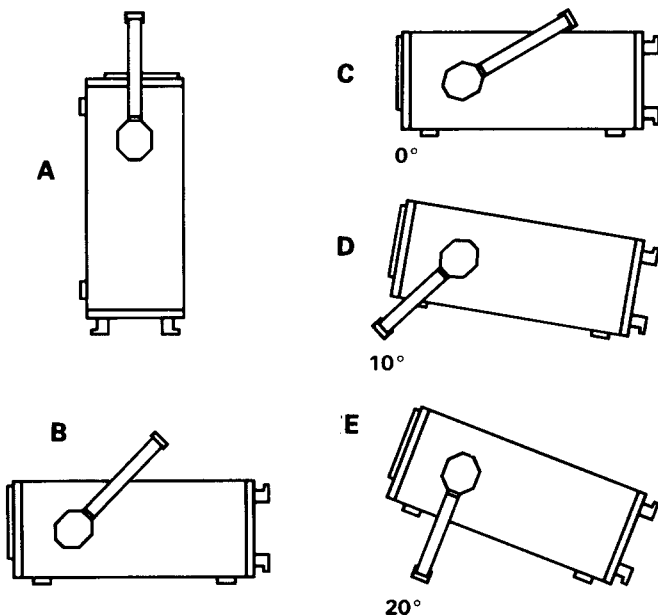

Safety

Attention!

The following safety information applies only if the interface on the rear panel of the oscilloscope is not used. **Prior to using the interface, the additional safety information on page M 24 must be read and observed.**

This instrument has been designed and tested in accordance with **IEC Publication 348, Safety Requirements for Electronic Measuring Apparatus**, and has left the factory in a safe condition. The present instruction manual contains important information and warnings which have to be followed by the user to ensure safe operation and to retain the oscilloscope in safe condition. **The case, chassis and all measuring terminals are connected to the protective earth contact of the appliance inlet.** The instrument operates according to **Safety Class I** (three-conductor power cord with protective earthing conductor and a plug with earthing contact). The mains/line plug shall only be inserted in a socket outlet provided with a protective earth contact. The protective action must not be negated by the use of an extension cord without a protective conductor.

The mains/line plug should be inserted before connections are made to measuring circuits.

The grounded accessible metal parts (case, sockets, jacks) and the mains/line supply contacts (line, neutral) of the instrument have been tested against insulation breakdown with **2000 Vr.m.s. (50Hz)**.

Under certain conditions, 50 Hz or 60 Hz hum voltages can occur in the measuring circuit due to the interconnection with other mains/line powered equipment or instruments. This can be avoided by using an isolation transformer (Safety Class II) between the mains/line outlet and the power plug of the instrument. **If a safety isolating transformer is used for recording of signals with a high zero potential, it should be kept in mind that this voltage is then also present in the enclosure and other accessible metal parts of the oscilloscope. Voltages up to 42V are not hazardous. Voltages higher than this can be dangerous or even lethal, however. Special safety precautions are required in these cases, and must be supervised by qualified personnel.**

Most cathode-ray tubes develop X-rays. However, **the dose equivalent rate falls far below the maximum permissible value of 36pA/kg (0.5 mR/h).**

Whenever it is likely that protection has been impaired, the instrument shall be made inoperative and be secured against any unintended operation. The protection is likely to be impaired if, for example, the instrument

- shows visible damage,
- fails to perform the intended measurements,
- has been subjected to prolonged storage under unfavourable conditions (e.g. in the open or in moist environments),
- has been subject to severe transport stress (e.g. in poor packaging).

Operating conditions

The instrument has been designed for indoor use. The permissible ambient temperature range during operation is +10°C ... +40°C. It may occasionally be subjected to temperatures between +10°C and -10°C without degrading its safety. The permissible ambient temperature range for storage or transportation is -40°C ... +70°C.

The maximum operating altitude is up to 2200m (non-operating 15000m). The maximum relative humidity is up to 80%.

If condensed water exists in the instrument it should be acclimatized before switching on. In some cases (e.g. extremely cold oscilloscope) two hours should be allowed before the instrument is put into operation. The instrument should be kept in a clean and dry room and must not be operated in explosive, corrosive, dusty, or moist environments. The oscilloscope can be operated in any position, but the convection cooling must not be impaired. **The ventilation holes may not be covered.** For continuous operation the instrument should be used in the horizontal position, preferably tilted upwards, resting on the tilt handle.

The specifications stating tolerances are only valid if the instrument has warmed up for 30 minutes at an ambient temperature between +15°C and +30°C. Values not stating tolerances are typical for an average instrument.

Guarantee

Each instrument runs through a quality test with 10 hour burn-in before leaving the production. Practically every early failure is detected in intermittent operation by this method. However, it is possible that a component fails only after a lengthy operating period. Therefore a **functional guarantee of 2 years** is given for all units. The condition for this is that no modifications have been made in the instrument. In the case of shipments by post, rail or carrier it is recommended that the original packing is carefully preserved. Transport damages and damage due to gross negligence are not covered by the guarantee.

In the case of a complaint, a label should be attached to the housing of the instrument which describes briefly the faults observed. If at the same time the name and telephone number (dialing code and telephone or direct number or department designation) is stated for possible queries, this helps towards speeding up the processing of guarantee claims.

Maintenance

Various important properties of the oscilloscope should be carefully checked at certain intervals. Only in this way is it largely certain that all signals are displayed with the accuracy on which the technical data are based. The test methods described in the test plan of this manual can be performed without great expenditure on measuring instruments. However, purchase of the new HAMEG **SCOPE TESTER HZ 60**, which despite its low price is highly suitable for tasks of this type, is very much recommended.

The exterior of the oscilloscope should be cleaned regularly with a dusting brush. Dirt which is difficult to remove on the casing and handle, the plastic and aluminium parts, can be removed with a moistened cloth (99% water +1% mild detergent). Spirit or washing benzene (petroleum ether) can be used to remove greasy dirt. The screen may be cleaned with water or washing benzene (but not with spirit (alcohol) or solvents), it must then be wiped with a dry clean lint-free cloth. Under no circumstances may the cleaning fluid get into the instrument. The use of other cleaning agents can attack the plastic and paint surfaces.

Power supply

The oscilloscope operates on line voltages between 100 V and 240 V AC. No means of switching to different input voltages has therefore been provided.

The power input fuse is externally accessible. The fuseholder is combined with the 3-pole power connector, and is located on its underside.

Never attempt to replace the fuse without first disconnecting the power cord. Now a small screwdriver can be used to pry out the fuseholder. The fuse itself can be pressed out towards the side, and its replacement inserted in the same way. When replacing the fuseholder (with the tab pointing up), make sure that it clicks securely into place.

Use of patched fuses or short-circuiting of the fuseholder is not permissible; HAMEG assumes no liability whatsoever for any damage caused as a result, and all warranty claims become null and void.

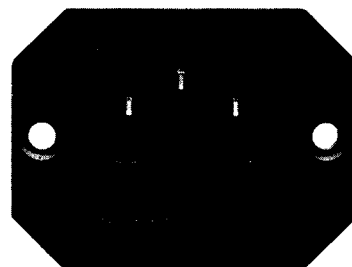

Fuse type: size **5 mm x 20 mm**, 1 A, 250-volt AC fuse; must meet IEC specification 127 sheet III (or DIN 41 662 or DIN 41 571, sheet 3). Time characteristic: **time-lag**.

Type of the signal voltage

With the HM 408, practically all periodically repeating signals with the frequency spectrum up to 40 MHz can be examined in the **analog real time mode**. (Because of the limited scanning rate, other limits which are further influenced by signal shape and screen amplitude apply in the digital storage mode.) The display of simple electrical processes, such as sinusoidal RF and LF signals or line frequency hum voltages is straightforward. When recording square-wave or pulse-type signal voltages, it must be noted that their **harmonics** must also be transmitted. The repetition frequency of the signal must therefore be significantly smaller than the upper limit frequency of the vertical amplifier. Accurate evaluation of such signals is only possible up to approximately 4 MHz repetition frequency. Displaying composite signals can be difficult, especially if they contain no repetitive higher amplitude content which can be used for triggering. This is the case with bursts, for instance. To obtain a well-triggered display in this case, the assistance of the variable holdoff and/or variable time control may be required. **Television video signals** are relatively easy to trigger using the built-in **TV-Sync-Separator (TV SEP)**.

For optional operation as a DC or AC voltage amplifier, the vertical amplifier input is provided with a **DC/AC** switch. The **DC** position should only be used with a series-connected attenuator probe or at very low frequencies or if the measurement of the DC voltage content of the signal is absolutely necessary.

When displaying very low frequency pulses, the flat tops may be sloping with **AC** coupling of the vertical amplifier (**AC** limit frequency approx. 1.6 Hz for -3dB). In this case, **DC** operation is preferred, provided the signal voltage is not superimposed on a too high DC level. Otherwise a capacitor of adequate capacitance must be connected to the input of the vertical amplifier with DC coupling. This capacitor must have a sufficiently high breakdown voltage rating. **DC** coupling is also recommended for the display of logic and pulse signals, especially if the pulse duty factor changes continuously. Otherwise the display will move upwards or downwards at each change. Pure direct voltages can only be measured with **DC** coupling.

Amplitude Measurements

In general electrical engineering, alternating voltage data normally refers to effective values (rms = root-mean-square value). However, for signal magnitudes and voltage designations in oscilloscope measurements, the peak-to-peak voltage (V_{pp}) value is applied. The latter corresponds to the real potential difference between the most positive and most negative points of a signal waveform.

If a sinusoidal waveform, displayed on the oscilloscope screen, is to be converted into an effective (rms) value, the resulting peak-to-peak value must be divided by $2 \times \sqrt{2} = 2.83$. Conversely, it should be observed that sinusoidal voltages indicated in V_{rms} (V_{eff}) have 2.83 times the potential difference in V_{pp} . The relationship between the different voltage magnitudes can be seen from the following figure.

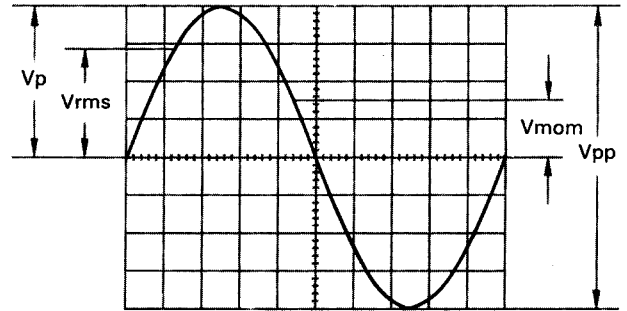

Voltage values of a sine curve

V_{rms} = effective value; V_p = simple peak or crest value;
 V_{pp} = peak-to-peak value; V_{mom} = momentary value.

The minimum signal voltage which must be applied to the Y input for a trace of 1 div. height is 1mV_{pp} when the **Y MAG.x5** pushbutton is depressed, the **VOLTS/DIV.** switch is set to **5mV/div.**, and the vernier is set to **CAL** by turning the **fine adjustment knob** of the VOLTS/DIV. switch clockwise all the way. However, smaller signals than this may also be displayed. The **deflection coefficients** on the input attenuators are indicated in **mV/div.** or **V/div.** (peak-to-peak value).

The magnitude of the applied voltage is ascertained by multiplying the selected deflection coefficient by the vertical display height in div.

If an attenuator probe x 10 is used, a further multiplication by a factor of 10 is required to ascertain the correct voltage value.

For exact amplitude measurements, the variable control on the attenuator switch must be set to its calibrated detent CAL. When turning the variable control ccw, the sensitivity will be reduced by a factor of 2.5.

Therefore every intermediate value is possible within the 1-2-5 sequence.

With direct connection to the vertical input, **signals up to 100V_{pp}** may be displayed (attenuator set to **5V/div.**, variable control to right stop).

With the designations

H = display height in div.,

U = signal voltage in V_{pp} at the vertical input,

D = deflection coefficient in **V/div.** at attenuator switch, the required quantity can be calculated from the two given quantities:

$$U = D \cdot H$$

$$H = \frac{U}{D}$$

$$D = \frac{U}{H}$$

However, these three values are not freely selectable. They have to be within the following limits (trigger threshold, accuracy of reading):

H between 0.5 and 8 div., if possible 3.2 to 8 div.,

U between 1 mV_{pp} and 40V_{pp},

D between 1 mV/div. and 5V/div. in 1-2-5 sequence.

Examples:

Set deflection coefficient **D** = 50 mV/div. \cong 0.05 V/div.,

observed display height **H** = 4.6 div.,

required voltage U = 0.05 · 4.6 = **0.23 V_{pp}**.

Input voltage **U** = 5V_{pp},

set deflection coefficient **D** = 1 V/div.,

required display height H = 5:1 = **5 div.**

Signal voltage $U = 220V_{rms} \cdot 2 \cdot \sqrt{2} = 622 V_{pp}$

(voltage > 40V_{pp}, with probe x100: **U** = 6.22 V_{pp}),

desired display height **H** = min. 3.2 div., max. 8 div.,

max. deflection coefficient **D** = 6.22 : 3.2 = 1.94 V/div.,

min. deflection coefficient **D** = 6.22 : 8 = 0.78 V/div.,

adjusted deflection coefficient D = **1 V/div.**

If the applied signal is superimposed on a DC (direct voltage) level the total value (DC + peak value of the alternating voltage) of the signal across the Y-input must not exceed $\pm 400V$ (see figure). This same limit applies to normal x10 attenuator probes, the attenuation ratio of which allows signal voltages up to approximately 400V_{pp} to be evaluated. Voltages of up to approximately 2,400V_{pp} may be measured by using the HZ53 high voltage probe which has an attenuation ratio of 100:1. It should be noted that its AC_{peak} value is derated at higher frequencies. If a normal x10 probe is used to measure high voltages there is the risk that the compensation trimmer bridging the attenuator series resistor will break down causing damage to the input of the oscilloscope. However, if for example only the residual ripple of a high voltage is to be displayed on the oscilloscope, a normal x10 probe is sufficient. In this case, an appropriate high voltage capacitor (approx. 22-68 nF) must be connected in series with the input tip of the probe.

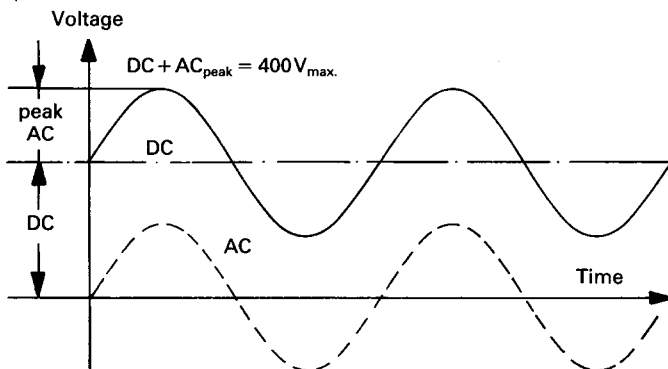

Total value of input voltage

The dotted line shows a voltage alternating at zero volt level. When superimposed a DC level, the addition of the positive peak and the DC voltage results in the max. voltage (DC + AC_{peak}).

It is very important that the oscilloscope input coupling is set to **DC**, if an attenuator probe is used for voltages higher than 400V (see page M6: Connection of Test Signal).

Reference Line

With **Y-POS.** control (input coupling to **GD**) it is possible to set a horizontal graticule line as **reference line for ground potential** before the measurement. It can lie below or above the horizontal central line according to whether positive and/or negative deviations from the ground potential are to be measured. Certain switchable x10/x1 attenuator probes also have a built-in ground reference switch position.

Time Measurements

As a rule, most signals to be displayed are periodically repeating processes, also called periods. The number of periods per second is the repetition frequency. Depending on the time base setting of the **TIME/DIV.** switch, one or several signal periods or only a part of a period can be displayed. The time coefficients are stated in **s/div.**, **ms/div.** and **μs/div.** on the **TIME/DIV.**-switch. The scale is accordingly divided into three fields.

There are 23 time coefficient ranges in the analog real time mode of the HM 408, from **0.05 μs/div. to 1 s/div.**

The Continuous or dashed black lines traced round the scale have no significance in the **analog mode** of the oscilloscope. The pushbutton **ms/s** to the left of the scale also has no function in this case. It is required only in the digital memory mode.

The duration of a signal period or a part of it is determined by multiplying the relevant time (horizontal distance in div.) by the time coefficient set on the TIME/DIV.-switch.

The variable time control (identified with an arrow knob cap) must be in its calibrated position CAL. (arrow pointing horizontally to the right). This variable control is inoperative in the storage mode.

With the designations

L = displayed wave **length in div.** of one period,

T = **time in seconds** for one period,

F = recurrence **frequency in Hz** of the signal,

T_c = **time coefficient in s/div.** on timebase switch and

the relation **F = 1/T**, the following equations can be stated:

$$T = L \cdot T_c \quad L = \frac{T}{T_c} \quad T_c = \frac{T}{L}$$

$$F = \frac{1}{L \cdot T_c} \quad L = \frac{1}{F \cdot T_c} \quad T_c = \frac{1}{L \cdot F}$$

With depressed X-MAG. x10 pushbutton the T_c value must be divided by 10.

However, these four values are not freely selectable. They have to be within the following limits:

- L** between 0.2 and 10 div., if possible 4 to 10 div.,
- T** between 0.05 μ s and 500 s,
- F** between 2 mHz and 40 MHz,
- T_c** between 0.05 μ s/div. and 50 s/div. in 1-2-5 sequence (with **X-MAG. x10** in out position), and
- T_c** between 5 ns/div. and 5 s/div. in 1-2-5 sequence (with pushed **X-MAG. x10** pushbutton).

Examples:

Displayed wavelength **L** = 7 div.,
 set time coefficient **T_c** = 0.05 μ s/div.,
required period T = $7 \cdot 0.05 \cdot 10^{-6} = 0.35 \mu$ s
required rec. freq. F = $1 : (0.35 \cdot 10^{-6}) = 2.86$ MHz.

Signal period **T** = 0.5 s,
 set time coefficient **T_c** = 0.2 s/div.,
required wavelength L = $0.5 : 0.2 = 2.5$ div..

Displayed ripple wavelength **L** = 1 div.,
 set time coefficient **T_c** = 10 ms/div.,
required ripple freq. F = $1 : (1 \cdot 10 \cdot 10^{-3}) = 100$ Hz.

TV-line frequency **F** = 15 625 Hz,
 set time coefficient **T_c** = 10 μ s/div.,
required wavelength L = $1 : (15\ 625 \cdot 10^{-5}) = 6.4$ div..

Sine wavelength **L** = min. 4 div.-, max. 10 div.,
 Frequency **F** = 1 kHz,
 max. time coefficient **T_c** = $1 : (4 \cdot 10^3) = 0.25$ ms/div.,
 min. time coefficient **T_c** = $1 : (10 \cdot 10^3) = 0.1$ ms/div.,
set time coefficient T_c = **0.2 ms/div.**,
required wavelength L = $1 : (10^3 \cdot 0.2 \cdot 10^{-3}) = 5$ div.

Displayed wavelength **L** = 0.8 div.,
 set time coefficient **T_c** = 0.5 μ s/div.,
pressed X-MAG. x10 button: T_c = 0.05 μ s/div.,
required rec. freq. F = $1 : (0.8 \cdot 0.05 \cdot 10^{-6}) = 25$ MHz,
required period T = $1 : (25 \cdot 10^6) = 40$ ns.

If the time is relatively short as compared with the complete signal period, an expanded time scale should always be applied (**X-MAG. x10** button pressed). In this case, the ascertained time values have to be divided by **10**. The time interval of interest can be shifted to the screen center using the **X-POS.** control.

When investigating pulse or square waveforms, the critical feature is the **risetime of the voltage step**. To ensure that transients, ramp-offs, and bandwidth limits do not unduly influence the measuring accuracy, the risetime is generally measured between **10%** and **90%** of the vertical pulse height. For peak-to-peak signal amplitudes of **5 div.** height, which are symmetrically adjusted to the horizontal center line, the internal graticule of the CRT has two horizontal dotted lines ± 2.5 div. from the center line. Adjust the **Y-POS.** control so that the pulse height is precisely aligned with these 0 and 100% lines. The 10% and 90% points of the signal will now coincide with the two lines, which have a distance of ± 2 div. from the horizontal center line and an additional subdivision of 0.2 div.. **The risetime is given by the product of the horizontal distance in div. between these two coincidence points and the time coefficient setting.** If magnification is used, this product must be divided by 10. The **fall time** of a pulse can also be measured by using this method.

The following figure shows correct positioning of the oscilloscope trace for accurate risetime measurement.

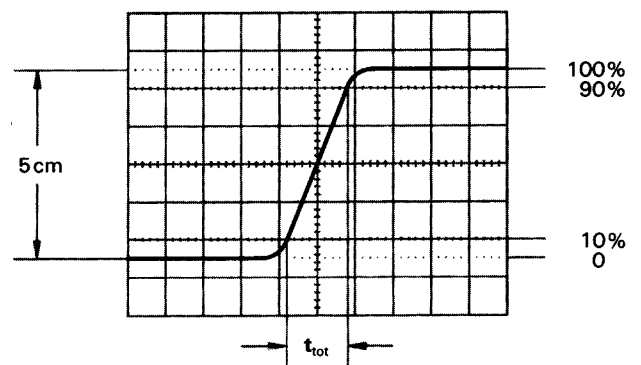

With a time coefficient of 0.1 μ s/div. and pushed **X-MAG x10** button the example shown in the above figure results in a measured total risetime of

$$t_{tot} = 1.6 \text{ div.} \cdot 0.1 \mu\text{s/div.} : 10 = 16 \text{ ns}$$

When very fast risetimes are being measured, the risetimes of the oscilloscope amplifier and of the attenuator probe has to be deducted from the measured time value. The risetime of the signal can be calculated using the following formula.

$$t_r = \sqrt{t_{tot}^2 - t_{osc}^2 - t_p^2}$$

In this t_{tot} is the total measured risetime, t_{osc} is the risetime of the oscilloscope amplifier (approx. 8.75 ns), and t_p the risetime of the probe (e.g. = 2 ns). If t_{tot} is greater than 64 ns, then t_{tot} can be taken as the risetime of the pulse, and calculation is unnecessary.

Calculation of the example in the figure above results in a signal risetime

$$t_r = \sqrt{16^2 - 8.75^2 - 2^2} = 13.24 \text{ ns}$$

The measurement of the rise or fall time is not limited to the trace dimensions shown in the above diagram. It is only particularly simple in this way. In principle it is possible to measure in any display position and at any signal amplitude. It is only important that the full height of the signal edge of interest is visible in its full length at not too great steepness and that the horizontal distance at 10% and 90% of the amplitude is measured. If the edge shows rounding or overshooting, the 100% should not be related to the peak values but to the mean pulse heights. Breaks or peaks (glitches) next to the edge are also not taken into account. With very severe transient distortions, the rise and fall time measurement has little sense. For amplifiers with approximately constant group delay (therefore good pulse transmission performance) the following numerical relationship between rise time **tr** (in ns) and bandwidth **B** (in MHz) applies:

$$tr = \frac{350}{B} \quad B = \frac{350}{tr}$$

Connection of Test Signal

Caution: When connecting unknown signals to the oscilloscope input, always use automatic triggering and set the **DC-AC** input coupling switch to **AC**. The attenuator switch should initially be set to **5V/div**.

Sometimes the trace will disappear after an input signal has been applied (OVERSCAN). The attenuator switch must then be turned back to the left, until the vertical signal height is only 3-8 div. With a signal amplitude greater than $100V_{pp}$, an attenuator probe must be inserted before the oscilloscope's vertical input. If, after applying the signal, the trace is nearly blanked, the period of the signal is probably substantially longer than the set value on the **TIME/DIV** switch. It should be turned to the left to an adequately larger time coefficient.

The signal to be displayed can be connected directly to the Y-input of the oscilloscope with a shielded test cable such as HZ 32 and HZ 34 or attenuated through a x10 or x100 attenuator probe. The use of test cables with high impedance circuits is only recommended for relatively low frequencies (up to approx. 50 kHz). For higher frequencies, the signal source must be of low impedance, i.e. matched to the characteristic resistance of the cable (as a rule 50 Ohm). Especially when transmitting square and pulse signals, a resistor equal to the characteristic impedance of the cable must also be connected across the cable directly at the Y-input of the oscilloscope. When using a 50 Ohm cable such as the HZ 34, a 50 Ohm through termination type HZ22 is available from HAMEG. When transmitting square signals with short rise times, transient phenomena on the edges

and top of the signal may become visible if the correct termination is not used. A terminating resistance is sometimes recommended with sine signals as well. Certain amplifiers, generators or their attenuators maintain the nominal output voltage independent of frequency only if their connection cable is terminated with the prescribed resistance. Here it must be noted that the terminating resistor HZ 22 will only dissipate a maximum of 2 Watts. This power is reached with $10V_{rms}$ or – at $28.3V_{pp}$ with sine signal.

If a x10 or x100 attenuator probe is used, no termination is necessary. In this case, the connecting cable is matched directly to the high impedance input of the oscilloscope. When using attenuator probes, even high internal impedance sources are only slightly loaded (approx. $10M\Omega \parallel 16pF$ or $100M\Omega \parallel 7pF$ with HZ 53). Therefore, if the voltage loss due to the attenuation of the probe can be compensated by a higher amplitude setting, the probe should always be used. The series impedance of the probe provides a certain amount of protection for the input of the vertical amplifier. Because of their separate manufacture, all attenuator probes are only partially compensated, therefore accurate compensation must be performed on the oscilloscope (see "Probe compensation" page M8).

Standard attenuator probes on the oscilloscope normally reduce its bandwidth and increase the rise time. In all cases where the oscilloscope band width must be fully utilized (e.g. for pulses with steep edges) we strongly advise using the **modular probes HZ 51** (x10) **HZ 52** (x10 HF) or **HZ 54** respectively (see oscilloscope accessories). This can save the purchase of an oscilloscope with larger bandwidth and has the advantage that defective components can be ordered from HAMEG and replaced by oneself. The probes mentioned have a HF-calibration in addition to low frequency calibration adjustment. Thus a group delay correction to the upper limit frequency of the oscilloscope is possible with the aid of a square-wave calibrator, switched to 1 MHz, e.g. HAMEG **Scope Tester HZ60**. In fact the bandwidth and rise time of the oscilloscope are not noticeably changed with these probe types and the waveform reproduction fidelity can even be improved because the probe can be matched to the oscilloscope's individual pulse response.

If a x10 or x100 attenuator probe is used, DC input coupling must always be used at voltages above 400 V. With **AC** coupling of low frequency signals, the attenuation is no longer independent of frequency, pulses can show pulse tilts. Direct voltages are suppressed but load the oscilloscope input coupling capacitor concerned. Its voltage rating is max. 400 V (DC + peak AC). **DC** input coupling is therefore of quite special importance with a x100 attenuation probe which usually has a voltage rating of max. 1200 V (DC + peak AC). A **capacitor** of corresponding capacitance and voltage rating may be connected **in series with**

the attenuator probe input for blocking DC voltage (e.g. for hum voltage measurement).

With all **attenuator probes, the maximum AC input voltage** must be **derated** with frequency usually above 20 kHz. Therefore the derating curve of the attenuator probe type concerned must be taken into account.

The selection of the ground point on the test object is important when displaying small signal voltages. It should always be as close as possible to the measuring point. If this is not done, serious signal distortion may result from spurious currents through the ground leads or chassis parts. The ground leads on attenuator probes are also particularly critical. They should be as short and thick as possible. When the attenuator probe is connected to a BNC-socket, a BNC-adaptor, which is often supplied as probe accessory, should be used. In this way ground and matching problems are eliminated.

Hum or interference appearing in the measuring circuit (especially when a small deflection coefficient is used) is possibly caused by multiple grounding because equalizing currents can flow in the shielding of the test cables (voltage drop between the protective conductor connections, caused by external equipment connected to the mains/line, e.g. signal generators with interference protection capacitors).

First Time Operation

Before applying power to the oscilloscope it is recommended that the following simple procedures are performed:

- Check that all pushbuttons are in the **out** position, i.e. released.
- Rotate the four variable controls, i.e. **TIME/DIV.** variable control, **CH.I** and **CH.II** attenuator variable controls, and **HOLD OFF** control to their calibrated detent.
- Set all controls with marker lines – except **LEVEL** (AT position) – to their midrange position (marker lines pointing vertically).
- The **TRIG.** selector lever switch in the X-field should be set to their uppermost position.
- Both **GD** switches for **CH.I** and **CH.II** in the Y-field should be set to the **GD** position (depressed).

Switch on the oscilloscope by depressing the red **POWER** pushbutton. An LED will illuminate to indicate working order. The trace, displaying one baseline, should be visible after a short warm-up period of 10 seconds. Adjust **Y-POS.I** and **X-POS.** controls to center the baseline. Adjust **INTENS.** (intensity) and **FOCUS** controls for medium brightness and optimum sharpness of the trace. The oscilloscope is now ready for use.

If only a spot appears (**CAUTION!** CRT phosphor can be damaged.), reduce the intensity immediately and check that the **X-Y** pushbutton is in the released (out) position. If the trace is not visible, check the correct positions of all knobs and switches (particularly **LEVEL** knob ccw).

To obtain the maximum life from the cathode-ray tube, the minimum intensity setting necessary for the measurement in hand and the ambient light conditions should be used.

Particular care is required when a single spot is displayed, as a very high intensity setting may cause damage to the fluorescent screen of the CRT. Switching the oscilloscope off and on at short intervals stresses the cathode of the CRT and should therefore be avoided.

The instrument is so designed that even incorrect operation will not cause serious damage. The pushbuttons control only minor functions, and it is recommended that before commencement of operation all pushbuttons are in the "out" position. After this the pushbuttons can be operated depending upon the mode of operation required.

The HM408 accepts all signals from DC (direct voltage) up to a frequency of at least 40MHz (-3dB). For sinewave voltages the upper frequency limit will be 60-70MHz. However, in this higher frequency range the vertical display height on the screen is limited to approx. 4-5 div. The time resolution poses no problem. For example, with 50MHz and the fastest adjustable sweep rate (5ns/div.), one cycle will be displayed every 4 div. The tolerance on indicated values amounts to $\pm 3\%$ in both deflection directions. All values to be measured can therefore be determined relatively accurately. However, from approximately 12MHz upwards the measuring error will increase as a result of loss of gain. At 15MHz this reduction is about 10%. Thus, approximately 11% should be added to the measured voltage at this frequency. As the bandwidth of the amplifiers differ (normally between 44 and 48MHz), the measured values in the upper limit range cannot be defined exactly. Additionally, as already mentioned, for frequencies above 40MHz the dynamic range of the display height steadily decreases. The vertical amplifier is designed so that the transmission performance is not affected by its own overshoot.

Trace Rotation TR

In spite of Mumetal-shielding of the CRT, effects of the earth's magnetic field on the horizontal trace position cannot be completely avoided. This is dependent upon the orientation of the oscilloscope on the place of work. A centred trace may not align exactly with the horizontal center line of the graticule. A few degrees of misalignment can be corrected by a potentiometer accessible through an opening on the front panel marked TR.

Use and Compensation of Probes

To display an undistorted waveform on an oscilloscope, the probe must be matched to the individual input impedance of the vertical amplifier.

The HM408's built-in calibration generator provides a squarewave signal with a very low risetime (<5ns), and switch-selectable frequencies of approx. 1 kHz and 1 MHz at two output sockets below the CRT screen. One output provides $0.2V_{pp} \pm 1\%$ for 10:1 probes, and $2V_{pp} \pm 1\%$ are present at the other, for 100:1 probes.

When the attenuator switches are set to **5mV/div** vertical deflection coefficient, these calibration voltages correspond to a screen amplitude of **4div**.

The output sockets have an internal diameter of 4.9mm to accommodate the internationally accepted shielding tube diameter of modern **Modular Probes** and **F-series** slimline probes. Only this type of construction ensures the extremely short ground connections which are essential for an undistorted waveform reproduction of non-sinusoidal high frequency signals.

Adjustment at 1 kHz

The C-trimmer adjustment compensates the capacitive loading on the oscilloscope input (approx. 25pF with the HM408). By this adjustment, the capacitive division assumes the same division ratio as the ohmic voltage divider to ensure an equal division ratio for high and low frequencies, as for DC. (For 1:1 probes or switchable probes set to 1:1, this adjustment is neither required nor possible). A baseline exactly parallel to the horizontal graticule lines is a major condition for accurate probe adjustments. (See also 'Trace Rotation **TR**', page M7.)

Connect the probes (Types HZ51, 52, 53, 54, or HZ36) to **CH.I** input. All pushbuttons should be released (in the 'out' position). Set the input coupling switch to **DC**, the attenuator switch to **5mV/div**, and the **TIME/DIV.** switch to **0.2ms/div**, and all variable controls to **CAL.** position. Plug the probe tip into the appropriate calibrator output socket, i.e. 10:1 probes into the **0.2V** socket, 100:1 probes into the **2.0V** socket.

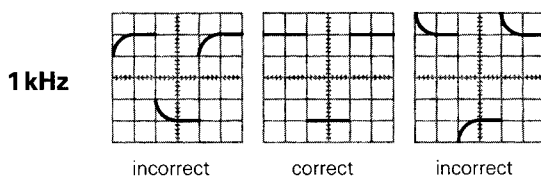

Approximately 2 complete waveform periods are displayed on the CRT screen. Now the compensation trimmer has to be adjusted. Normally, this trimmer is located in the probe head. On the 100:1 probe HZ53, however, it is located in the connecting box at the other end of the cable. Using a

small insulated non-metallic screwdriver or trimming tool, the trimmer has to be adjusted slowly until the tops of the squarewave signal are exactly parallel to the horizontal graticule lines. (See Fig. above for 1 kHz.) The signal amplitude shown should be $4\text{ cm} \pm 1.2\text{ mm}$ (= 3%). During this adjustment, the signal edges will remain invisible.

Adjustment at 1 MHz

Probes HZ51, 52, 54 and HZ37 will also allow for HF-adjustments. They incorporate resonance deemphasizing networks (R-trimmer in conjunction with inductances and capacitors) which permit – for the first time – probe compensation in the range of the upper frequency limit of the vertical oscilloscope amplifier. Only this compensative adjustment ensures optimum utilisation of the full bandwidth, together with constant group delay at the high frequency end, thereby reducing characteristic transient distortion near the leading signal edge (e.g. overshoot, rounding, ringing, holes or bumps) to an absolute minimum.

Using the probes HZ51, 52, and 54, the full bandwidth of the HM408 can be utilized without risk of unwanted waveform distortion.

Prerequisite for this HF-adjustment is a squarewave generator with fast risetime (typical 4ns), and low output impedance (approx. 50Ω), providing 0.2V and 2V at a frequency of approx. 1MHz. The calibrator output of the HM408 meets these requirements when the pushbutton 1 MHz is depressed.

Connect the probe to **CH.I** input. Depress the calibrator pushbutton **1MHz**. All other pushbuttons should be released ('out' position). Set the input coupling switch to **DC**, attenuator switch to **5mV/cm**, and **TIME/DIV.** switch to **0.1μs/cm**. Set all variable controls to **CAL.** position.

Insert the probe tip into the output socket marked **0.2V**. A waveform will be displayed on the CRT screen, with leading and trailing edges clearly visible. For the HF-adjustment now to be performed, it will be necessary to observe the rising edge as well as the upper left corner of the pulse top. To gain access to the HF-compensation trimmer, the plastic cover of the probe connecting box has to be slid off after unscrewing the probe cable. The connecting boxes of the HZ51, 54 and HZ37 contain one R-trimmer screw, each, while that of the HZ52 provides three. These R-trimmers have to be adjusted in such a manner that the beginning of the pulse top is as straight as possible. Overshoot or excessive rounding are unacceptable. This is relatively easy on the HZ51, 54 and HZ37, but slightly more difficult on the HZ52. The rising edge should be as steep as possible, with the pulse top remaining as straight and horizontal as possible.

On the HZ52, each of the three trimmers has a clearly defined area of influence on the waveform shape (see Fig.), offering the added advantage of being able to 'straighten out' waveform aberrations near the leading edge.

Adjustment points of the probes

HZ51, HZ54

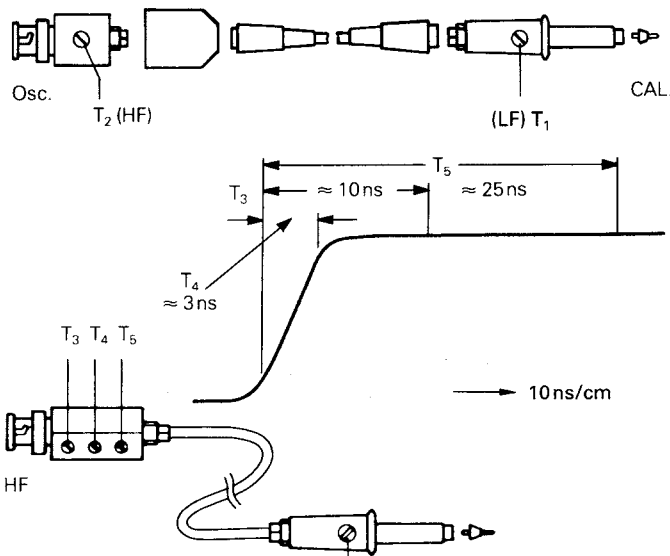

T₃: alters the middle frequencies
T₄: alters the leading edge
T₅: alters the lower frequencies

HZ52

After completion of the HF-adjustment, the signal amplitude displayed on the CRT screen should have the same value as during the 1 kHz adjustment.

Probes other than those mentioned above, normally have a larger tip diameter and may not fit into the calibrator outputs. Whilst it is not difficult for an experienced operator to build a suitable adapter, it should be pointed out that most of these probes have a slower risetime with the effect that the total bandwidth of scope together with probe may fall far below that of the HM1005. Furthermore, the HF-adjustment feature is nearly always missing so that waveform distortion can not be entirely excluded.

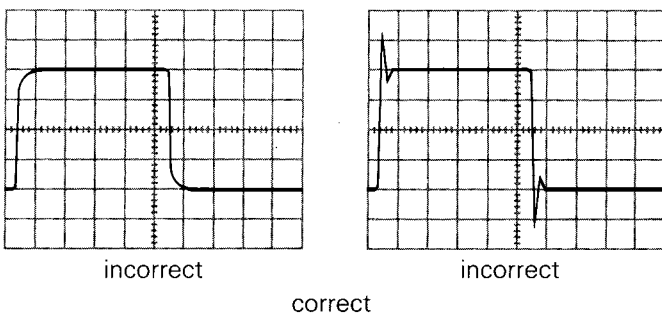

**Adjustment
1 MHz**

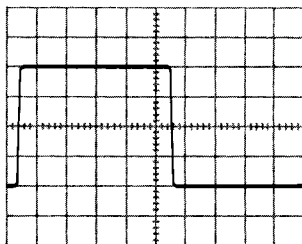

The adjustment sequence must be followed in the order described, i.e. first at 1 kHz, then at 1 MHz. The calibrator frequencies should not be used for timebase calibrations. The pulse duty cycle deviates from 1:1 ratio.

Prerequisites for precise and easy probe adjustments, as well as checks of deflection coefficients, are straight horizontal pulse tops, calibrated pulse amplitude, and zero-potential at the pulse base. Frequency and duty cycle are relatively unimportant. For interpretations of transient response, fast pulse risetimes and low-impedance generator outputs are of particular importance.

Providing these essential features, as well as switch-selectable output-frequencies, the calibrator of the HM408 can, under certain conditions, replace expensive squarewave generators when testing or compensating wideband-attenuators or -amplifiers. In such a case, the input of an appropriate circuit will be connected to one of the **CAL.**-outputs via a suitable probe.

The voltage provided at a high-impedance input ($1\text{ M}\Omega \parallel 15\text{--}50\text{ pF}$) will correspond to the division ratio of the probe used ($10:1 = 20\text{ mV}_{pp}$, $100:1 = \text{also } 20\text{ mV}_{pp}$ from 2 V output). Suitable probes are HZ51, 52, 53, and 54.

For low-impedance inputs (e.g. $50\ \Omega$), a 1:1 probe can be employed which, however, must be fully terminated with a $50\ \Omega$ through-termination. Suitable probe types are HZ50 and HZ54. The latter must be switched to the 1:1 position, and the HF-trimmer in the connecting box turned fully counterclockwise.

When connected to the **0.2V CAL.** socket, and using the HZ50, this arrangement will provide approx. 40 mV_{pp} at $50\ \Omega$ circuit input, and approx. 24 mV_{pp} if the HZ54 is used. The voltages given here will have larger tolerances than 1 % since operation of a 1:1 probe together with a $50\ \Omega$ load is very uncommon.

Using the **2V CAL.** socket under similar conditions is only possible with the **HZ54** probe. The potential obtained at the $50\ \Omega$ input will then be approx. 190 mV_{pp} , but with almost twice the risetime. Accurate readings of the available input voltage can be shown directly on the HM408 when connecting a $50\ \Omega$ through-termination between the BNC plug of the probe and the input of the oscilloscope.

Operating modes of the vertical amplifiers

The vertical amplifier is set to the desired operating mode by using the 3 pushbuttons in the Y field of the front panel. For **Mono** mode all 3 buttons must be in their released positions; only **channel I** can then be operated. The button **CH I/II-TRIG.I/II** must be depressed in mono mode for **Channel II**. The internal triggering is simultaneously switched over to Channel II with this button.

If the **DUAL** button is depressed, both channels are working. Two signals can be displayed together in this button position (alternate mode). This mode is not suitable for displaying very slow-running processes. The display then flickers too much or it appears to jump. If the **CHOP.** button is depressed in addition to **DUAL**, both channels are switched

over constantly at a high frequency within a sweep period (CHOP mode). Slow running processes **below 1 kHz or with time coefficients higher than 1ms/div.** are then also displayed without flicker. The dual mode chosen is less important for signals with higher repetition frequency.

If the **ADD** button is depressed, the signals of both channels are algebraically added ($I \pm II$). Whether the resulting display shows the **sum** or **difference** is dependent on the phase relationship or the polarity of the signals **and** on the positions of the **INV. CHII** button.

In-phase input voltages:

INV. CHII button released = sum.

INV. CHII button depressed = difference.

Antiphase input voltages:

INV. CHII button released = difference.

INV. CHII button depressed = sum.

In the **ADD** mode the vertical display position is dependent upon the **Y-POS.** setting of **both** channels. The **same attenuator switch position** is normally used for both channels with algebraic addition.

Differential measurement techniques allow direct measurement of the voltage drop across floating components (both ends above ground). Two identical probes should be used for both vertical inputs. Using a separate ground connection and **not** connecting the probe or cable shields to the circuit under test avoid ground loops (hum, common-mode disturbances).

X-Y Operation

For **X-Y mode** press the **X-Y MODE** button in the X field of the front panel. The X signal is then derived from the **Channel II (HOR. INP.)**. **The calibration of the X signal during X-Y operation is determined by the setting of the Channel II input attenuator and variable control.** This means that the sensitivity ranges and input impedances are identical for both the X and Y axes. However, the **Y-POS.II** control is disconnected in this mode. Its function is taken over by the **X-POS.** control. It is important to note that the **X-MAG. x10** facility, normally used for expanding the sweep is inoperative in the X-Y mode. It should also be noted that the bandwidth of the X amplifier is approximately 2.5 MHz (-3dB), and therefore an increase in phase difference between both axes is noticeable from 50 kHz upwards.

The Y-Input signal may be inverted by using the **INVERT** facility. However, the inversion of the X-input signal using the CH. II **INVERT** button is not possible in analog mode.

Lissajous figures can be displayed in the **X-Y mode** for certain measuring tasks:

- Comparing two signals of different frequency or bringing one frequency up to the frequency of the other signal.

This also applies for whole number multiples or fractions of the one signal frequency.

- Phase comparison between two signals of the same frequency.

Phase comparison with Lissajous figure

The following diagrams show two sine signals of the same frequency and amplitude with different phase angles.

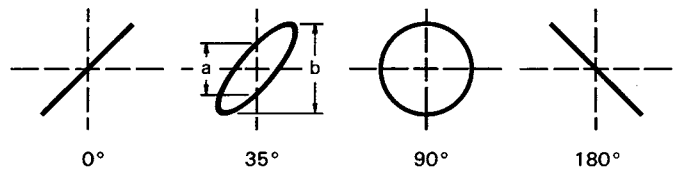

Calculation of the phase angle or the phase shift between the X and Y input voltages (after measuring the distances **a** and **b** on the screen) is quite simple with the following formula and a pocket calculator with trigonometric functions and besides **independent of both deflecting amplitudes** on the screen.

$$\sin \varphi = \frac{a}{b}$$

$$\cos \varphi = \sqrt{1 - \left(\frac{a}{b}\right)^2}$$

$$\varphi = \arcsin \frac{a}{b}$$

The following must be noted here:

- Because of the periodic nature of the trigonometric functions, the calculation should be limited to angles $\leq 90^\circ$. However here is the advantage of the method.
- Do not use a too high test frequency. The phase shift of the two oscilloscope amplifiers of the HM408 in the X-Y mode can exceed an angle of 3° above 120 kHz.
- It cannot be seen as a matter of course from the screen display if the test voltage leads or lags the reference voltage. A CR network before the test voltage input of the oscilloscope can help here. The $1 \text{ M}\Omega$ input resistance can equally serve as R here, so that only a suitable capacitor C needs to be connected in series. If the aperture width of the ellipse is increased (compared with C short-circuited), then the test voltage leads the reference voltage and vice versa. This applies only in the region up to 90° phase shift. Therefore C should be sufficiently large and produce only a relatively small just observable phase shift.

Should both input voltages be missing or fail in the X-Y mode, a very bright light dot is displayed on the screen. This dot can burn into the phosphor at a too high brightness setting (INTENS. knob) which causes either a lasting loss of brightness, or in the extreme case, complete destruction of the phosphor at this point.

Phase difference measurement in DUAL mode

A larger phase difference between two input signals of the same frequency and shape can be measured very simply on the screen in Dual mode (**DUAL** button depressed). The time base should be triggered by the reference signal (phase position 0). The other signal can then have a leading or lagging phase angle. Alternate mode should be selected for frequencies ≥ 1 kHz; the Chop mode is more suitable for frequencies < 1 kHz (less flickering). For greatest accuracy adjust not much more than one period and approximately the same height of both signals on the screen. The variable controls for amplitude and time base and the **LEVEL** knob can also be used for this adjustment – without influence on the result. Both base lines are set onto the horizontal graticule center line with the **Y-POS.** knobs before the measurement. With sinusoidal signals, observe the zero (crossover point) transitions; the sine peaks are less accurate. If a sine signal is noticeably distorted by even harmonics, or if an offset direct voltage is present, **AC** coupling is recommended for **both** channels. If it is a question of pulses of the same shape, read off at steep edges.

Phase difference measurement in dual mode

t = horizontal spacing of the zero transitions in div.

T = horizontal spacing for **one period** in div.

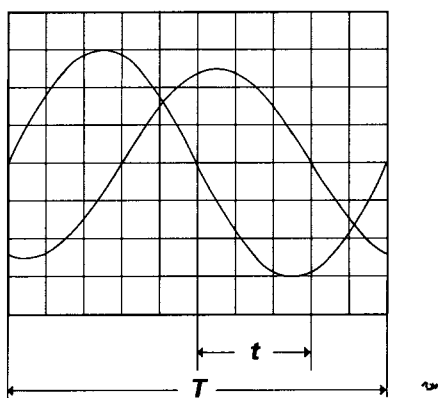

Figure 1
Amplitude and frequency spectrum for AM display ($m = 50\%$)

The display of the amplitude-modulated HF oscillation can be evaluated with the oscilloscope in the analog mode provided the frequency spectrum is inside the oscilloscope bandwidth. The time base is set so that several wave of the modulation frequency are visible. Strictly speaking, triggering should be external with modulation frequency (from the AF generator or a demodulator). However, internal triggering is frequently possible with normal triggering (**AT/NORM.** button depressed) using a suitable **LEVEL** setting and possibly also using the time variable adjustment.

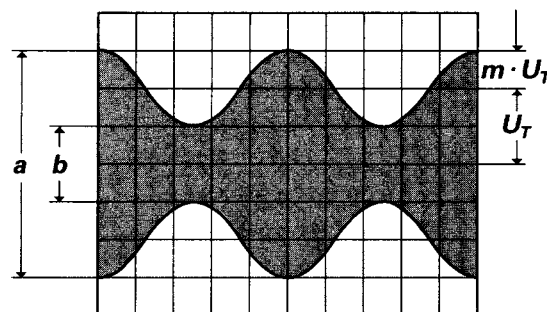

Figure 2
Amplitude modulated oscillation: $F = 1$ MHz; $f = 1$ kHz;
 $m = 50\%$; $U_T = 28.3$ mV_{rms}.

Oscilloscope setting for a signal according to figure 2:

Depress no buttons. **Y: CH. I; 20 mV/div.; AC.**

TIME/DIV.: 0.2 ms/div.

Triggering: **NORMAL** with **LEVEL**-setting; **internal (or external) triggering.**

If the two values a and b are read from the screen, the modulation factor is calculated from

$$m = \frac{a - b}{a + b} \text{ resp. } m = \frac{a - b}{a + b} \cdot 100 [\%]$$

where $a = U_T(1+m)$ and $b = U_T(1-m)$.

In certain cases (e.g. proportioning of a terminating resistor, diameter of wire of a modulation transformer, examination of an AM-tuning diode for cross modulation etc.), the following formula is of advantage:

In the example illustrated, $t = 3$ div. and $T = 10$ div. The phase difference in degrees is calculated from

$$\varphi^\circ = \frac{t}{T} \cdot 360^\circ = \frac{3}{10} \cdot 360^\circ = 108^\circ$$

or expressed in radians

$$\text{arc } \varphi = \frac{t}{T} \cdot 2\pi = \frac{3}{10} \cdot 2\pi = 1,885 \text{ rad}$$

Relatively small phase angles at not too high frequencies can be measured more accurately in the X-Y mode with Lissajous figures.

Measurement of an amplitude modulation

The momentary amplitude u at time t of a HF-carrier voltage, which is amplitude modulated without distortion by a sinusoidal AF voltage, is in accordance with the equation

$$u = U_T \cdot \sin \Omega t + 0,5m \cdot U_T \cdot \cos(\Omega - \omega)t - 0,5m \cdot U_T \cdot \cos(\Omega + \omega)t$$

where U_T = unmodulated carrier amplitude

$\Omega = 2\pi F$ = angular carrier frequency

$\omega = 2\pi f$ = modulation angular frequency

m = modulation factor ($\leq 1 \triangleq 100\%$).

$$\frac{U_{ss}}{U_{rms}} = 2 \cdot \sqrt{2} \cdot \frac{1+m}{\sqrt{1+\frac{m^2}{2}}}$$

U_{ss} = peak-to-peak amplitude of an AM-voltage

U_{rms} = effective voltage value of U_{ss} (on sine modulation only)

The variable controls for amplitude and time can be set arbitrarily in the modulation factor measurement. Their position does not influence the result.

Triggering and time base

A signal can be displayed only if the time base is running or triggered. To produce a stationary display, triggering must be synchronous with the test signal. This is possible by using the test signal itself or by an externally supplied but synchronous signal voltage.

The trigger voltage should have a certain minimum amplitude. This value is called the **trigger threshold**. It is measured with a sine signal. When the trigger voltage is taken internally from the test signal, the trigger threshold can be stated as vertical **display height in mm**, through which the time base generator starts, the display is stable, and the trigger LED lights.

The internal trigger threshold of the HM408 is given as ≤ 0.5 div. When the trigger voltage is externally supplied, it can be measured in V_{pp} at the **TRIG. INP.** socket. Normally, the trigger threshold may be exceeded up to a maximum factor of 20.

The HM408 has two trigger modes, which are characterized in the following.

Automatic Triggering

With the **LEVEL** knob in locked position (turned ccw to **AT** = automatic triggering) the sweep generator is running without test signal or external trigger voltage. A base line is always displayed even without a signal applied. This trigger mode is therefore called **Automatic Triggering**. Operation of the scope needs, having a constantly visible trace, only a correct amplitude and time base setting. A **LEVEL** adjustment is neither necessary nor possible with automatic triggering. This simple **AT** mode is recommended for all uncomplicated measuring tasks. However, automatic triggering is also the appropriate operation mode for the "entry" into difficult measuring problems, e.g. when the test signal is unknown relating to amplitude, frequency or shape. Presetting of all parameters is now possible with automatic triggering; the change to normal triggering can follow thereafter.

The automatic triggering works above **10Hz** up to at least **80MHz**. The changeover to the break down of the automatic triggering at frequencies below 10Hz is abrupt. However,

it can not be recognized by the **TRIG.** LED; this is still blinking. Break down of triggering is best recognizable at the left screen edge (the start of the trace in differing display height).

The automatic triggering follows immediately all variations or fluctuations of the test signal above 10Hz. However, if the pulse duty factor of a square-wave signal changes so much that one part of the square-wave reduces to a needle pulse, switching over to normal triggering and using the **LEVEL** control can be necessary. With automatic triggering, the trigger point lies approx. in the zero voltage crossing. The time interval, required for the time base start, can be too short at a steep zero crossing of the needle pulse. Then normal triggering should be used.

Automatic triggering is practicable not only with internal but also with external trigger voltage.

Normal Triggering

With normal triggering (**Level** knob **not** in **AT** position) and **LEVEL** adjustment, the sweep can be started by signals within the frequency range selected by the **TRIG.** coupling switch. **In the absence of an adequate trigger signal or when the trigger controls (particularly the LEVEL control) are misadjusted, no trace is visible.**

In storage mode, the most recently sampled waveform remains stored in memory.

When using the internal normal triggering mode, it is possible to trigger at any amplitude point of a signal edge, even with very complex signal shapes, by adjusting the **LEVEL** control. Its adjusting range is directly dependent on the display height, which should be at least **0.5 div.** If it is smaller than 1 div., the **LEVEL** adjustment needs to be operated with a sensitive touch. In the external normal triggering mode, the same applies to approx. 0.2V external trigger voltage amplitude.

Other measures for triggering of very complex signals are the use of the time base variable control and **HOLDOFF** time control, hereinafter mentioned.

Slope

The trigger point can be placed alternatively on a rising or falling edge of the test signal. This is valid with automatic and with normal triggering. The selected slope is set with the **+/-** button. The plus sign (button released) means an edge, which is coming from a negative potential and rising to a positive potential. That has nothing to do with zero or ground potential and absolute voltage values. The positive slope may also lie in a negative part of a signal. A falling edge (minus sign) triggers, when the **+/-** button is depressed. However, with normal triggering, the trigger point may be varied within certain limits on the chosen edge using the **LEVEL** control.

Trigger coupling

The coupling mode and accordingly the frequency range of the trigger signal can be changed using the **TRIG.** selector switch. However, this is possible only with the **TV SEP.** switch in unlocked (out) position.

AC: **Trigger range $\geq 10\text{Hz}$ to 20MHz .**

This is the most frequently used trigger mode. The trigger threshold is increasing below 10 Hz.

DC: **Trigger range DC to 20MHz .**

DC triggering is recommended, if the signal is to be triggered with quite slow processes or if pulse signals with constantly changing pulse duty factors have to be displayed.

Always work with normal triggering and LEVEL adjustment.

Otherwise there is the possibility in the **AT** position (automatic triggering) that the trigger point may change or that triggering may not occur with signals without zero crossing (e.g. with DC offset). Sometimes triggering is easier with **AC input coupling**, because the signal then has its average value exactly at the oscilloscope's ground potential.

HF (H): Trigger range 15kHz to 80MHz (high-pass filter).

The HF position is suitable for all radio-frequency signals. DC fluctuations and low-frequency excess noise of the trigger voltage are suppressed, giving a stable display. The trigger threshold increases below 15 kHz.

LF (V): Trigger range DC to 1kHz (low-pass filter).

The LF position is often more suited for low-frequency signals than the DC position, because the (white) noise in the trigger voltage is strongly suppressed. So jitter or double-triggering of complex signals is avoidable or at least reduced, in particular with very low input voltages. The trigger threshold increases above 1 kHz.

Line triggering

A part of a secondary winding voltage of the power transformer is used as mains/line frequency trigger signal (50 to 60 Hz) in the \sim position of the **TRIG.** selector switch. This trigger mode is independent of amplitude and frequency of the Y signal and is recommended for all mains/line synchronous signals. This also applies – within certain limits – to whole number multiples or fractions of the line frequency. Line triggering can also be useful to display signals below the trigger threshold (less than 0.5 div). It is therefore particularly suitable for measuring small ripple voltages of mains/line rectifiers or stray magnetic field in a circuit.

Magnetic leakage (e.g. from a power transformer) can be investigated for direction and amplitude using a search or pick-up coil. The coil should be wound on a small former with a maximum of turns of a thin lacquered wire and connected to a BNC connector (for scope input) via a shielded cable. Between cable and BNC center conductor a resistor of at least 100Ω should be series-connected (RF decoupling). Often it is advisable to shield statically the surface of the coil. However, no shorted turns are permissible. Maximum, minimum, and direction to the magnetic source are detectable at the measuring point by turning and shifting the coil.

Triggering of video signals

The built-in active **TV-Sync-Separator** separates the sync pulses from the video signal, permitting the display of distorted video signals either in line (**H** = horizontal) or in frame (**V** = vertical) trigger mode.

Video signals are triggered in the automatic mode. Therefore the adjustment of the trigger point is superfluous. The internal triggering is virtually independent of the display height, which may differ from 0.8 to 8 div.

The **TIME/DIV.** switch can be set according to the measurement task independently of the **TV** switch position. For TV triggering, depress and lock the **TV SEP.** button. Now use the trigger coupling switch to select either line pulse triggering [**HF(H)**] or field pulse triggering [**LF(V)**]. The integration required in the LF(V) position prevents all synchronization pulses from becoming visible. If the sync pulses at the test object are above the picture (field) contents, then the SLOPE pushbutton (+/-) must be in + position (undepressed), since the slope of the leading edge of the synchronization pulse is decisive. In the case of sync pulses below the field, the leading edge is negative and the SLOPE pushbutton must therefore be depressed (to “-”).

In the 5 ms/div setting, with TV triggering $2\frac{1}{2}$ fields are visible; at 10 $\mu\text{s}/\text{div}$ only $1\frac{1}{2}$ lines are visible.

However, the **TIME/DIV.** knob may be turned more to the right (without break down of the triggering), if more details in the video signal should be required. More advantageous, because one video field is suppressed, is the use of the 10-fold expansion with the **X-MAG. x10** button and the **HOLD-OFF** time setting. Disconnecting the trigger circuit (e.g. by rapidly pressing and releasing the **EXT.** button) can result in triggering the consecutive (odd or even) field.

Setting: **LF (V)**, **2ms/div.**, **HOLDOFF** knob at the left stop, **X-MAG. x10** button depressed, searching the picture detail with **X-POS.** knob. So the International Insertion Test Signals including Video Text and VPS etc. in the vertical blanking interval are fully visible with a 25:1 expansion ratio.

The sync-separator-circuit also operates with external triggering. It is important that the voltage range ($0.2V_{pp}$ to $2V_{pp}$) for external triggering should be noted. In addition, the correct slope setting is again critical, because the external trigger signal may not have the same polarity or pulse edge as the test signal. This can be checked, if the external trigger voltage itself is displayed at first (with internal triggering).

Generally, the composite video signal has a high DC content. With a constant video information (e.g. test pattern or color bar generator), the DC content can be suppressed easily by **AC** input coupling of the oscilloscope amplifier. With a changing picture content (e.g. normal program), **DC** input coupling is recommended, because the display varies its height on screen with **AC** input coupling at each change of the picture content. The DC content can be compensated using the **Y-POS.** control so that the signal display lies in the graticule area. Then the composite video signal should not exceed a vertical height of 6 div.

External triggering

The internal triggering is disconnected by depressing the **EXT.** button. The timebase can be triggered **externally** via the **TRIG. INP.** socket using a $0.2V_{pp}$ to $2V_{pp}$ voltage, which is in synchronism with the test signal. This trigger voltage may have completely different form from the test signal voltage. Triggering is even possible – in certain limits – with whole number multiples or fractions of the test frequency, but only in locked phase relation.

The input impedance of **TRIG. INP.** socket is approx. $1M\Omega || 25pF$. The maximum input voltage of the input circuit is 100V (DC + peak AC). Only $2V_{pp}$ maximum are required for a good external triggering.

Trigger indicator

An LED on condition (above the **TRIG.** switch) indicates that the sweep generator is triggered. This is valid with automatic and with normal triggering. The indication of trigger action facilitates a sensitive **LEVEL** adjustment, particularly at very low signal frequencies. The indication pulses are of only 100ms duration.

Thus for fast signals the LED appears to glow continuously, for low repetition rate signals, the LED flashes at the repetition rate or – at a display of several signal periods – not only at the start of the sweep at the left screen edge, but also at each signal period.

Holdoff-time adjustment

If it is found that a trigger point cannot be located on extremely complex signals even after repeated and careful

adjustment of the **LEVEL** control in the **normal triggering** mode, a stable display may be obtained using the **HOLD-OFF** control (in the X-field). This facility varies the hold-off time between two sweep periods approx. up to the ratio 10:1. Pulses or other signal waveforms appearing during this off period cannot trigger the timebase. Particularly with burst signals or aperiodic pulse trains of the same amplitude, the start of the sweep can be delayed until the optimum or required moment.

A very noisy signal or a signal with a higher interfering frequency is at times double displayed. It is possible that LEVEL adjustment only controls the mutual phase shift, but not the double display. The stable single display of the signal, required for the evaluation, is easily obtainable by expanding the holdoff time. To this end the HOLDOFF knob is slowly turned to the right, until one signal is displayed.

A double display is possible with certain pulse signals, where the pulses alternately show a small difference of the peak amplitudes. Only a very exact **LEVEL** adjustment makes a single display possible. The use of the **HOLD-OFF** knob simplifies the right adjustment.

After specific use the **HOLD-OFF** control should be re-set into its calibration detent, otherwise the brightness of the display in analog mode is reduced drastically. The function is shown in the following figures.

Function of var. HOLD-OFF control

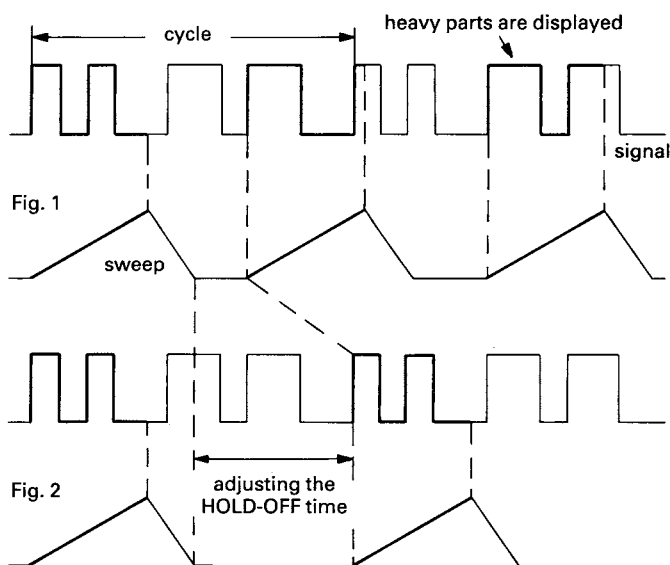

Fig. 1 shows a case where the **HOLD-OFF** knob is in the minimum position and various different waveforms are overlapped on the screen, making the signal observation unsuccessful. Fig. 2 shows a case where only the desired parts of the signal are stably displayed.

Y Overscanning Indication

This indicating facility shows any overscanning of the usable screen dimensions *in the vertical direction*, if the baseline or signal portions are not within the graticule. The indication is achieved by 2 light-emitting diodes, marked **OVERSCAN**, which are located in the center between the attenuators. Should one LED illuminate without an input signal, this means that the respective vertical positioning control has been improperly adjusted. Because each LED correlates with one of both possible directions, it can be seen in which direction the trace has left the screen. With dual channel operation, misadjustment of both **Y-POS.** controls can occur. If both traces lie in the same direction, one LED illuminates likewise. If one trace is positioned above and the other below the graticule, both LEDs are illuminated. The indication of the Y position after crossing the graticule area occurs **in each operating mode**, also when, due to missing time deflection, no baseline is displayed, or when the oscilloscope is in the X-Y mode.

As previously written in the paragraph "First Time Operation", the **LEVEL** control knob should be switched in **AT** position (ccw), as a baseline is then permanently displayed,

also without any input signal. The trace disappears at times after applying an input signal. The LED indication shows, in which direction the trace has left the screen, above or below the graticule. Illumination of both LEDs at the same time after applying a signal means that the vertical deflection has overscanned the graticule edges in both vertical directions. With **DC** input coupling and an applied signal with a relatively high DC offset, smaller sizes also of displayed signals can overscan the raster edges, because the DC voltage causes a vertical position shift of the display height, which seemed correctly adjusted. In this case, a smaller display height must be accepted, or **AC** input coupling has to be selected.

Scale Illumination

Especially for the photographic recording of displays, the oscilloscope has a *raster illumination*. Normally, the raster, which is necessary for the point-by-point evaluation, is not visible without illumination. In the unlocked position, the illumination is switched off.

Possibly some test pictures are required for a good representation of the graticule and/or the readout.

Readout

The readout, which can be additionally switched on, provides the user with additional support to facilitate evaluation of signal traces, in both analog and storage mode.

The readout information is displayed when the **READOUT INTENS.** control (underneath the CRT screen) is turned in a clockwise direction out of the **OFF** position. When the signal focus is correctly adjusted, this will also yield the optimum READOUT focus, provided that the READOUT intensity corresponds to the signal intensity.

In realtime (analog) mode, interruptions of the waveform display are possible. This depends on the signal frequency, the time coefficient setting, and the selected vertical amplifier mode (mono, dual alternate or dual chopped). Interference of this kind can be eliminated by switching off the readout.

The readout data relevant to the current mode is inserted at the top and bottom edges of the scope screen.

Trigger READOUT display:

This display appears at the top left, indicating the trigger source and the trigger type. In **XY** realtime and **ROLL** (storage) operation, no triggering is performed and consequently no information is displayed.

If internal triggering is employed, "**T1**" or "**T2**" is displayed (for channel I or II, respectively); "**TX**" indicates external triggering.

If automatic triggering is being used, then "**AUTO**" is displayed.

With **NORMAL** triggering (**LEVEL** control *not* in **AT** position), then that voltage is displayed that is required to trigger a sweep at the selected **LEVEL** and correctly set SLOPE.

The indicated voltage refers to the scope input and is therefore dependent on the volts/division switch setting when using internal triggering. If the oscilloscope input is uncalibrated, then a "greater than" (>) symbol appears instead of "=" . The **LEVEL** setting range is at least 16 cm. As a result, even when the vertical amplifier is purposefully set to an excessively high level, it is possible to use a signal component for triggering that is outside of the visible range (8 cm) of the CRT screen and also identify this signal component.

If a divider probe is used, then its attenuation must be taken into account. With a **10:1** probe and the display "**T1 = 0.504V**", the voltage required at the test object in order to trigger a sweep is, accordingly, 5.04 volts. In order to stipulate a trigger voltage of 0.504 V, the VOLTS/DIV. switch must not be in the positions 50 mV/div, 20 mV/div, etc.

The trigger voltage readout can - depending on the **LEVEL** adjuster - display either positive or negative voltages, referenced to an input voltage of 0 V (switch the input to **GD** and use **AT** triggering to set the 0V trace position with **Y-POS** control).

In order to obtain a correct trigger voltage readout - correct in the sense that it is consistent with the input signal, disregarding tolerances and trigger comparator hysteresis - both the input coupling and the trigger coupling must be switched to **DC** coupling. Otherwise DC components and thus also the proper relationship to the input signal will be lost.

PRETRIGGER and PLOT I+II:

Readout is only possible in a few storage modes. In these cases, the display appears at the top in the middle. Consult "operating controls of the storage section and their functions".

CURSOR measurement display:

With the aid of the X or Y cursor that can be additionally switched on, voltage, time and frequency measurements can be performed. The resulting measurement values are displayed at the top right of the screen. In XY realtime and storage mode no values are displayed.

Channel I deflection coefficient:

At the lower left edge of the screen, the deflection coefficient set with the **VOLTS/DIV** switch for Channel I is displayed, also taking into consideration the optional additional 5x magnification of the vertical axis with "**x 5 Y MAG**". This information is only displayed in those vertical amplifier modes in which Channel I is active: Channel I, Dual, Addition, and XY mode.

The displayed deflection coefficient is referenced to the input signal of Channel I. If, for example, measurements are being performed in the **5 mV/div** setting and the Y fine adjustment knob of Channel I is in the **CAL** position (turned clockwise all the way), then the following display is obtained: "**CH1=5mV**". If the input is not calibrated, then the display "**CH1>5mV**" is obtained.

When performing measurements with a divider probe, the attenuation ratio must be taken into account.

Channel II deflection coefficient:

Display of the deflection coefficient of Channel II is also at the lower screen edge, to the right of the display for Channel I. The deflection coefficient is displayed for the following operating modes: Channel II, Dual, Addition, and XY.

Inversion of Channel II can occur, but this only has technical significance for measurements in addition mode (in the other modes, it results only in an altered display). Inversion is indicated by a "plus-minus" sign in front of the Channel II display (e.g. **CH1=20mV±CH2=20mV**).

Time deflection coefficient:

The time deflection coefficient selected using the **TIME/DIV** switch is displayed on the bottom right-hand edge of the screen. In XY realtime and storage modes, "XY-MODE" is displayed.

If, for example, the **TIME/DIV** switch is in the calibrated position $50\mu\text{s}/\text{div}$, then the display "**TB=50 μs** " is obtained. Since the fine adjustment knob of the time base is only active in realtime (analog) operation, that is also the only situation in which ">" can be displayed instead of "=".

When the **HOLD** function is used, in storage mode the read-out display is changed, e.g. from "**TB=50 μs** " to "**E0=50 μs** ". Here, "E0" stands for "expansion zero". If - except in the case of expansion - the storage time base is exited, then "RANGE ?" is displayed. An exception to this is in the **CLK.EXT** position; in this case, "TB EXT" (external time base) is displayed.

If the input signal is depicted with a horizontal magnification factor of x10, then the displayed time deflection coefficient is correspondingly altered.

CURSOR control and measurements:

The pushbuttons required for these functions are located in the control field below the CRT screen, to the right of the **READOUT INTENS.** control. The **CURSORS** cannot be made visible without a **READOUT** display.

The following controls are available for manipulation of the cursors:

The **left-hand CURSOR I** button is used to move the cursor to the left or down.

The **right-hand CURSOR I** button is used to move the cursor to the right or up.

The **left-hand CURSOR II** button is used to move the cursor to the left or down.

The **right-hand CURSOR II** button is used to move the cursor to the right or up.

When the **TRACK** button is pressed, the pushbuttons for **CURSOR I** simultaneously manipulate **CURSOR II** as well.

The **controls** for measurement **functions** are:

- **Δt** pushbutton for period duration measurements.
- **ΔU** pushbutton for voltage measurements.
- **Δt** and **ΔU** pushbuttons for frequency measurements.

If one or both of these buttons is pressed once, then the desired measurement function is called and the cursors come into view, provided that this is not prevented, e.g. because the scope is currently being operated in XY mode. The CURSOR measurement display also appears along with the cursors. Pressing the same button(s) a second time results in the cursors being switched off again. However, it is also possible to directly switch to a different func-

tion. In order to perform frequency measurements, press the **Δt** and the **ΔU** buttons together.

If a function is called by pressing a button and holding it depressed, then the corresponding function will be alternatively switched on and off for as long as the button remains depressed.

The cursor lines differ from one another in appearance.

CURSOR I is represented by a **continuous dotted line**, whereas **CURSOR II** has the form of a **series of broken dashes**.

Two pushbuttons are assigned to each cursor line. The **upper** two pushbuttons are used to control **CURSOR I**. If period or frequency measurement is being performed, then holding the left-hand button depressed causes the position of CURSOR I to slowly move towards the left. Conversely, holding the righthand cursor I button depressed causes CURSOR I to shift to the right.

When performing voltage measurements, the left-hand button can be used to move CURSOR I to the bottom of the screen, the right-hand button to move it to the top of the screen. The corresponding directions are graphically indicated by symbols on the front panel of the scope.

CURSOR II is controlled by the lower two buttons, which affect CURSOR II analogously to the two buttons for CURSOR I.

The only exception is **TRACK** mode.

TRACK mode is activated by pressing the corresponding button once, and deactivated by pressing the button a second time. When TRACK is active, no change occurs in the behavior of CURSOR II, but manipulating the buttons for CURSOR I results in both cursors being simultaneously moved.

Besides being moved slowly or, by briefly pressing the buttons, in discrete individual steps, it is also possible to shift the cursors rapidly. To do so, press the corresponding CURSOR once briefly, release it, and immediately press it again (now holding it depressed).

CURSOR-supported measurements:

ΔU (voltage) measurements are performed using the **horizontal** CURSOR lines, which are approx. 8 cm long. The results of voltage measurement are indicated in the **READOUT** by the CURSOR measurement display. They are referenced to the selected vertical deflection coefficient (without taking the attenuation of the divider probe, if used, into account) and are indicated in V_{pp} (volts peak-to-peak).

The displayed measurement value is always calculated with respect to **CURSOR I**; this fact is important for determining

the correct polarity. If a positive DC voltage is being measured, then **CURSOR I** must be moved to the 0 volt position of the trace (to be determined by pressing **GD**). After releasing **GD**, the signal trace will shift upwards. Now move **CURSOR II** to this position. The CURSOR measurement display will now read, for example, " ΔU_1 1.620V". If the positions of CURSOR I and CURSOR II had been reversed, then the displayed result would now have the opposite sign: " $\Delta U_1 - 1.620V$ ", and would thus be incorrect.

If the Y input is uncalibrated, then the result is displayed as a percentage, with a 5-cm distance between CURSOR I and CURSOR II representing 100%.

In **DUAL** mode, the CURSOR measurement reading refers to the channel selected using the **CH1/II + TRIG.I/II** button.

If, in **ADDITION** mode, the Y deflection coefficients of both channels are identical, then the following reading will be obtained: " ΔU_1^2 ...". If one of the two channels deviates from the other (e.g. if it is not calibrated), then "**CH<>CH2**" is displayed.

Δt (time/period) measurements are performed using the **vertical** CURSOR line, which are approx. 7 cm long. In this

case as well, the measurement results appear in the CURSOR measurement readout, and are referenced to the (calibrated) time/division setting. If the horizontal deflection coefficient is uncalibrated (possible only in realtime – analog – mode), then the following is displayed: " Δt UNCAL".

Changes made to the horizontal deflection coefficient, either by changing the time/division setting, by inserting additional horizontal magnification by pressing **X MAG** (x 10), or by **SOFTWARE** expansion (only possible in storage mode), are taken into account.

For Δt measurements as well, CURSOR I should be moved to the reference point of the input signal. Now move CURSOR II to the position of the signal being measured, and take the reading in the display. If the signal is in front (to the left) of CURSOR I, then negative values will be obtained, e.g. " $\Delta t - 3.80\mu s$ ".

Frequency measurements are performed like time difference measurements, however the measured time period is converted and displayed as a frequency. It does not matter whether CURSOR II is to the left or to the right of CURSOR I; in neither case will a negative sign result.

Storage Operation

Controls and indicators of the storage section and their functions

The controls and indicators for operation of the oscilloscope in storage mode are located, with the single exception of "PLOT", in the X field, and are framed in to set them apart.

STOR.: When this pushbutton is locked in its depressed position, the oscilloscope is switched from analog (realtime) to storage operation. When this is done, the STOR. LED lights up. Pressing the button again releases it, returning the scope to analog mode and extinguishing the LED. Any signals previously stored with **HOLD** remain in memory, but readout data can be lost.

The **STOR. LED** lights up continuously to indicate that storage mode is active. If the LED flashes on and off, then the **TIME/DIV.** switch is incorrectly set. This can be the case if it is set to outside of the blackbordered TIME/DIV scale, or – when the **ms/s** button is depressed – if it is set to outside of the area marked by a dotted line. An exception to this is when software expansion is used to access a setting beyond the TIME/DIV scale, provided that the maximum possible expansion ("E3" in the display) is not exceeded. If this is nevertheless done, then the LED will flash on and off and "RANGE?" will be displayed instead of the time/division setting. This also applies to time period and frequency measurements.

If the time/division switch is set to the **CLK.EXT.** position (external clock), then the STOR. LED will not flash on and off, and "**TB EXT**" will appear in the readout.

DOT J. (DOT JOIN): This button is used to join successive dots captured from an input signal; they are joined by luminous lines (linear interpolation). This serves to improve waveform recognition, especially in the case of high frequencies, but also when successively displaying a large number of signal periods. Signals with steep edges, e.g. square-wave pulses, can be slightly distorted by the dot-joining function. This button should therefore only be used when really needed.

The **HOLD I** and **HOLD II** buttons are used to save the current memory contents of the corresponding channels. In mono operation with **CHANNEL I**, it is sufficient to depress the **HOLD I** button into its locked position; in mono operation with **CHANNEL II**, the **HOLD II** button must be depressed. In **DUAL** and **XY** operation, it is advisable to use both **HOLD I and HOLD II**. The size of the characters used to display the channel in the readout (e.g. CH1...) is reduced when the corresponding HOLD button is pressed, and a frame consisting of dots also appears around it. If the corresponding HOLD button(s) is (are) depressed in mono or dual mode, then "TB=..." is replaced by "E0=..." in the readout.

It is possible for operating mistakes to cause data saved with HOLD to be lost. This can happen, for instance, if the HOLD I button is pressed in mono operation with Channel I, and then if the scope is switched over to mono operation with Channel II without first pressing the HOLD II button.

When the scope is in Mono I and the HOLD I button is depressed, switching to DUAL does not result in loss of the saved waveform (although the resolution on the x axis is reduced from 4k to 2k). Not until after this has been done is it possible to switch the trigger source to Channel II with **CHI/CHII - TRIG.I/II**. The waveform in Channel I can then be utilized as a reference signal. Channel II is then used for display of a signal for comparison with the reference signal (CHI); the signal in Channel II can then be saved.

If a **HOLD** button is depressed in the middle of a sampling period, then the sampling operation is immediately interrupted. The waveform stored in memory from the next-to-last sampling operation then reappears in the screen. The resulting breakpoint can cause interference to the "old" memory contents. In this case, it is better to perform signal sampling in SINGLE RESET mode. The resulting single sweep will clear the old memory contents. The HOLD button should not be pressed until after this single sweep has been completed, the data have been stored, and the waveform image has appeared on-screen.

SINGLE pushbutton: This is used to switch the storage time base from periodic sweeps to single-scan mode. If a scan is in progress when SINGLE mode is switched too, the scan is first completed. If the **ms/s** switch is in its **s** (for seconds) position, then the completion of the scan is depicted as a roll operation (the signal is moved to the left-hand screen edge).

In this way, nonrepetitive waveforms (like power-up or power-down events, or randomly occurring signals) can be displayed with uniform screen brightness and stored for as long as desired.

This pushbutton is only functional in storage mode.

RESET pushbutton: If, after a sweep has been completed, the RESET button is pressed while the SINGLE button is in its depressed position, the the RESET LED lights up. This indicates that the oscilloscope is ready to perform a single scan. After a single scan has been carried out, pressing the RESET pushbutton causes the RESET LED (which has gone out) to light up again, thus indicating that the HM 408 is ready to capture another waveform.

If the **ms/s** switch is in its **ms** (for milliseconds) position, then no changes occur in the screen display until an appro

riate trigger signal arrives. At that time, the RESET LED goes out, and the newly captured signal is displayed.

With the **ms/s** switch in its **s** position, the resulting display is different. In this case as well, the SINGLE button must first be locked into its depressed position. As already described in connection with SINGLE, the current sweep is completed in form of a ROLL display. Then – and not before – pressing the RESET button causes the RESET LED to light up, and the displayed waveform shifts towards the left and off the screen; simultaneously being cleared from memory. If a trigger event then occurs – provided that PRETRIGGER has previously been set to 0%, in other words effectively disabled – the RESET LED extinguishes again. The signal event triggering a sweep initially appears at the right-hand edge of the screen, and then shifts towards the left.

Once the trigger signal has reached the left-hand edge of the screen, the memory is full and no further changes occur. At this point the waveform data in memory can be saved, if wished, by pressing HOLD, just like when the ms/s switch is set to “ms”.

If the **ms/s** switch is set to “s”, then measurements with PRETRIGGER (25/50/75 or 100%) can only be performed in SINGLE mode. The following can happen with the pretrigger function: at 50% pretrigger and a time/division setting of 1 s/div, the displayed signal prehistory has a duration of 5 seconds. If RESET is pressed to start, then the displayed waveform moves towards the left. If a trigger event occurs after 2 seconds, then it is displayed. The RESET LED does not extinguish, however, since the pretrigger condition (50%) cannot be met. After an additional 8 seconds the displayed signal event moves out beyond the left-hand screen edge and is thus also removed from memory. If a trigger event occurs now, the RESET LED extinguishes, and capture is terminated after another 5 seconds. The trigger signal is now at the middle of the screen (50%), and the called-for 50% prehistory is also displayed.

The RESET LED also lights up when the oscilloscope is not in SINGLE mode. This indicates readiness for capture of a new waveform.

PRETRIG. pushbutton: The PRETRIGGER function is used to display signals that occur *prior* to a trigger event. It can be varied in 25% steps from 0% to 100%. In 0% position the pretrigger function is deactivated.

The pretrigger setting is performed with the pretrigger pushbutton, and is displayed in the readout. Each press of the button results in the setting being advanced by an additional 25%. The sequence is: 0%, 25%, 50%, 75%, 100%, 0%. If the pushbutton is held continuously depressed, then the value continues to advance in sequence.

The displayed pretrigger value refers to the screen display. For instance, at 50% pretrigger with the time/division switch set to 1 ms/div. the displayed prehistory (i.e. signals prior to the trigger event) extends back over a time period of 5 ms (50% of 10 divisions x 1 ms. In this example, the trigger event is displayed in the middle of the screen.

With the ms/s switch set to “ms”, the pretrigger function is active in the REFRESH and SINGLE modes. In refresh mode, repetitive signals are periodically scanned.

With the ms/s set to “s”, measurement is performed without pretrigger (0%), since otherwise excessively long wait times would result when displaying repetitive signals.

In **SINGLE** mode, the pretrigger function can **also** be used in the “s” timedivision range.

TIME/DIV. rotary switch: When storage mode is active, the digitally generated, crystal-controlled time base with fixed frequencies is utilized for display purposes. The time-base fine adjustment knob is then disabled. Because the sampling rate is limited to a maximum frequency of **40 MHz**, and because of the resulting memory depth of **4k** (4000 samples, displayed over 10 divisions in the x direction), the smallest selectable time coefficient in storage mode is **10 µs/division**. This can - initially - be increased to **50 ms/division**. This range is surrounded by a black border on the **TIME/DIV.** scale. It is enabled when the **ms/s** switch is set to “ms” (in its released position). Measurements can then be performed in either SINGLE or REFRESH mode.

Since even larger time/division coefficients are useful when using the scope in storage mode, they can be expanded by a **factor of 1000**. To do so, set the **ms/s** switch to “s” (seconds). The area of the scale surrounded by the dashed border is now enabled. Now time coefficients between 50 s and 0.1 s per division can be selected. Only now can ROLL mode be utilized.

SOFTWARE expansion: As already mentioned above in the section on HOLD, it is possible to expand signal components after saving them with HOLD. However, in general use should only be made of this feature if it is not possible to achieve the same result by using a faster sampling rate (i.e. smaller time/division coefficients).

When performing measurements in MONO mode, 4k bytes are displayed over 10 cm. With 10x software expansion, 400 bytes are depicted over 10 cm. The remaining 3600 bytes are linearly interpolated, calculated, and displayed. The same process is applied analogously in DUAL mode.

To make use of this feature, first adjust the trace (with the **X-POS** control) so that it begins precisely at the left-hand edge of the screen graticule.

The beginning of the signal section which it is wished to expand is marked with cursor I. Accordingly, the readout must be switched on with Δt or f for frequency values displayed, in order to permit positioning of the cursor. If cursor I is too close to the right-hand edge of the graticule, then - depending on the expansion factor - it is possible for the expanded waveform to appear, followed in the center of the screen by a horizontal line not belonging to the signal.

Example: If cursor I is 4 cm from the right-hand edge of the screen graticule and an expansion factor of 2x has been selected, the 4-cm signal section will be expanded to fill a space of 8 cm. Consequently, 2 cm of the 10-cm-wide screen display will remain without any signal representation at all. Instead, as already mentioned, a horizontal line is depicted in this area.

Depending on the current time/division coefficient, after saving the waveform by pressing HOLD, the TIME/DIV. switch can be turned clockwise up to a maximum of 3 additional positions. When this is done, the readout display changes from E0 to E1, E2, and E3, and the unexpanded signal representation is overwritten by the recalculated waveform (magnified 10x). "RANGE?" appears in the readout to indicate operating errors. This also occurs if it is wished to reverse the expansion but the switch is accidentally turned one or more positions too far in the counterclockwise direction. "E0" appears in the display as soon as the TIME/DIV switch has been returned to the position in which the data had been saved with HOLD.

Because of the 1-2-5 sequence of the time/division coefficient settings, different expansion factors result.

Example:

Readout:	E0	E1	E2	E3
TIME/DIV.:	50 μ s	20 μ s	10 μ s	5 μ s
Factor:	0	2,5	5	10
TIME/DIV.:	20 μ s	10 μ s	5 μ s	2 μ s
Factor:	0	2	4	10
TIME/DIV.:	10 μ s	5 μ s	2 μ s	1 μ s
Factor:	0	2	5	10

Additional magnification of the x-axis can be obtained with X-MAG.x10. Consequently, the largest possible expansion factor is 100x. The signal section under study is first made visible using the horizontal position control (X-POS). In this case as well, the time base, t or frequency values displayed in the readout are corrected. If the contents of memory are transferred to external devices for documentation purposes, then the magnification performed with X-MAG.x10 is ignored.

The situation is different with software expansion. If an XY or YT recorder is used for documentation, then the software-

expanded signal is transferred. By contrast, when transferring data to the HAMEG Graphic Printer or to another device using an RS-232C or IEEE-488 interface, the unexpanded signal is transmitted together with the corresponding readout data.

CLK. EXT.: If the TIME/DIV switch is set to CLK. EXT (the 1 s/div position for analog mode) while the scope is in storage mode, then the internal time base is deactivated. "TB EXT" is then displayed in the readout. An external clock signal can now be applied by way of the BNC connector on the scope rear panel. When doing so, the following conditions must be met:

Max. frequency:	10 MHz
Input voltage:	0 to +5 V
Low signal:	0 to +0.3 V
High signal:	+3 V to +5 V
Duty cycle:	1:1 in mono channel I or mono channel II mode
Sampling pulse duration:	>45 ns for high signals in DUAL mode
Signal edge for sampling:	Positive-going signal edge in DUAL mode

External clock signals can be used for all storage measurement modes. If the frequency of the external time-base signal < 2 kHz, then it is recommended to set the **ms/s** switch to its "s" position. In general, SOFTWARE expansion is not possible when using an external clock signal.

ROLL pushbutton: If this pushbutton is depressed into its locked position, and if the **ms/s** time-range switch is set to "s" (seconds), then ROLL mode is active. In this mode, neither triggering nor pretriggering is possible. As a result, the corresponding data is not displayed in the readout, either. In ROLL mode the representation of a displayed signal moves from the right-hand screen edge to the left-hand screen edge. Each change in the signal first becomes visible on the right-hand screen edge, and then gradually shifts towards the left. The speed with which it does so depends on the TIME/DIV setting (50 s/div. to 0.1 s/div.). As long as a signal is being displayed, it can be saved at any time with HOLD.

This feature allows a certain pulse constellation or noise reading to be search for, stored and studied, even with aperiodic or random signals. With control circuits, it is also possible to identify the propagation of a disturbance as a function of time or capture dead times, even though the point in time at which the disturbance is relayed through the circuit cannot be influenced and must be waited for. This mode permits display of all changes in a waveform, since measurements are taken continuously without triggering and thus also without hold-off times.

XY MODE: If STOR. is depressed and if the X-Y MODE pushbutton (outside of the storage control field) is locked in its depressed position, then the HM 408 is in XY storage mode. This differs from XY realtime (analog) in the following respects:

The time base is enabled, since no signal sampling can be performed without it (unless an external clock signal is applied).

The vertical position control for Channel II (Y-POS.II) functions as a horizontal position control while X-POS. is disabled. INV. CHII can be used to invert the input signal for Channel II.

The pretrigger and cursor functions are disabled, while the trigger source, the trigger type (AUTO = automatic), and the trigger voltage level (for normal triggering) are displayed in the readout.

Waveforms can be captured and stored in SINGLE mode. Software expansion and the X-MAG.x10 magnification function are disabled.

If measurements are performed with excessively small deflection coefficients, then the sampling rate is so high that complete sampling operations are no longer possible on an X or Y signal period. This results in gaps in the display.

If a time/division setting is selected that is too large, then several periods will be sampled. If the X and Y signals are not phase-coupled with one another, then the result will be a display with poor definition. This does, however, reflect the varying phase relationships that arise during sampling and capture.

If it is wished to measure periodic (repetitive) signals, then it is advisable to switch off XY mode, and to select a TIME/DIV setting in DUAL mode that results in display of at least 1 signal period in each channel over the entire 10-cm width of the screen. Then switch back to XY mode.

As already mentioned, the Y-POS.II control functions as a horizontal position control in XY storage mode. The marking on top of the Y-POS.II knob (Y position control for Channel II) should be pointing straight up, unless a DC voltage component must be compensated for. The maximum deflection range of the A/D converter is approx. 10 cm; however, it is only in XY mode that the resulting limitations at the left and right edges of the graticule are recognizable and cause distortion when approached. When using XY storage mode, therefore, it is advisable to always use a format that does not exceed 8cmx8cm (positioned symmetrically around the screen center).

In order to save a displayed waveform in XY storage mode, it is sufficient to press one of the HOLD buttons. This is then indicated in the readout for both channels.

PLOT I+II: This pushbutton is only active in storage mode. It is located outside of the storage control field. PLOT I+II is used to output serial signal data by way of the 26-pole HAMEG interface on the scope rear panel. PLOT I+II can only be used if HOLD or SINGLE is depressed. Signal output can then be performed:

- 1) with an external HAMEG interface to an XY or YT recorder, or
- 2) with an external HAMEG RS-232C (V.24) interface to a computer with an appropriate port.

After pressing PLOT I+II once, the pretrigger setting in the readout is replaced by "V9600BD". This signifies RS-232C (V.24) transmission, at a rate of 9600 bauds. If no further action is taken, the pretrigger display reappears.

In order to change to a different baud rate or to recorder operation, proceed as follows:

First press PLOT I+II. Then press the left-hand CURSOR I pushbutton once. "V1200BD" will now appear in the readout. Pressing this button again switches to 300 bauds, and yet again to "PL40SEC".

The scope is now in recorder mode; 30-, 20- and 10-second settings are also possible. Pressing the button again switches back to "V9600BD". If the right-hand CURSOR I pushbutton is pressed, the display order is: PL10, 20, 30, 40SEC, VD300BD, etc.

The output rate (e.g. PL20SEC) in recorder mode is based on a signal curve with a length of 10 cm. In this example, the output rate would be 2 s/division (the total duration of transmission is 20 seconds, divided by 10 divisions).

Independently of whether any changes have been made or not: when PLOT I+II is pressed a second time the displayed setting is executed, provided that HOLD or SINGLE is depressed.

In RS-232C (V.24) mode, 256 bytes containing the readout data are transferred to the computer, followed by 1x4k bytes (in mono or addition mode) or 2x2k bytes (in dual or XY mode) containing the signal data. After the data transfer, the displayed baud rate is blanked out. At 9600 baud the transfer takes approx. 5 seconds, at 1200 baud approx. 40 seconds, and at 300 baud approx. 4 minutes.

A special case exists if it is wished to perform automatic data transfer in RS232C (V.24) mode with the scope in SINGLE mode. After locking the SINGLE button into its depressed position, press PLOT I+II once to determine whether the correct baud rate is set. After 5 seconds, the HM408 blanks the baud rate display again. The RESET function of the HM408 must then be activated by the computer (the RESET LED lights up when this is done). Then, the computer must continually query its serial input. After a trigger event and complete waveform acquisition, the captured

data are transferred to the computer via the RS-232C (V.24) interface. As soon as the data transfer has been completed, the computer must again send a signal to enable the RESET function, thus readying the scope for capture of another event.

If the scope is used in recorder mode ("PL..." appears in the readout), then the data are transferred to the recorder as soon as PLOT I+II is pressed a second time. This operation is also depicted on the scope screen, although with reduced brightness. At the same time, the readout is switched off. Prior to the actual start of data transmission, the recorder pen is moved to its starting position. A "pen-down" command is then issued, causing the pen to be lowered to the paper. At the end of transmission, a "pen-lift" command raises the pen again, and the scope switches back to normal display mode. With the setting "PL40SEC", the signal curve is plotted in 40 seconds (MONO Channel I or II, XY mode, and ADD Channel I + II). If the HM 408 is in DUAL mode, then both signal curves are output in succession, each taking 40 seconds to be transmitted and plotted. After Channel I has been output, the recorder pen is lifted, moved to the start of the signal for Channel II, and lowered again. The second curve is then plotted.

Plotting of both signal curves - captured in DUAL or XY mode - in the way described above is not possible with YT recorders, but only with XY recorders. No readout data is output in recorder mode.

Transmission can be interrupted by pressing RESET, but only in recorder mode.

The analog output voltages of the recorder interface are 0.1 V/div. for X and Y.

X-MAG.x10 magnification of the x-axis does not affect signal output in any way. Software expansion is only taken into consideration in recorder mode (PL...).

Storage resolution and operating modes

Vertical resolution

Dot density in each operating mode 8 bit = $2^8 = 256$ dots on 10 div. display height (25 dots per div.). However only 8 div. can be evaluated in the screen graticule.

Horizontal resolution in timebase mode

Channel I alone: Dot density 12 bit = $2^{12} = 4096$ dots on 10 div. display width (400 dots per div.).

Channel II alone: Dot density 12 bit = $2^{12} = 4096$ dots on 10 div. display width (400 dots per div.).

Channel I and II (DUAL button depressed): Dot density 11 bit = $2^{11} = 2048$ dots on 10 div. display width (200 dots per div.) **for each channel.**

Sum and difference CHI ± CHII (ADD button without/with INV. CHII button depressed): Dot density 12 bit = $2^{12} = 4096$ dots on 10 div. display width (400 dots per div.).

XY-operation: 25 dots per div. in vertical and horizontal direction.

Horizontal resolution with X-MAG. x10 button

Depressing the **X-MAG. x10** button produce no effect on the stored data; these remain completely unchanged. However, the display is 10-fold expanded in the X-direction. The dot density changes from 400 (200) to 40 (20) dots per div.

Maximum signal frequency in storage mode

The highest capturable signal frequency cannot be exactly defined, since it depends to a large extent on the waveform and the displayed amplitude (vertical deflection) of the signal. With the start of each sweep, the signal voltage at the inputs of the analog-to-digital converter is briefly measured (sampled), converted to an 8-bit digital value, and written into a RAM. The next sampled value is converted in the same way, but stored at the next RAM address.

The time intervals between the individual signal samples are determined by the time-base setting. At the maximum sampling rate of 40 megasamples/s (40MHz) – at the time-base setting 10µs/div. – in MONO mode each analog-to-digital converter is briefly switched to "measurement", doing so at 25ns intervals. Assuming that 20 measurements per signal period are sufficient, this yields a minimum period duration of $20 \times 25\text{ns} = 500\text{ns}$, corresponding to a maximum signal frequency of 2MHz. Since the storage depth of memory is 4k – i.e. 4096 measurements – and the trace is displayed over a width of approx. 10.2div., 40 sampling values are depicted within a horizontal deflection of 0.1div. For evaluation purposes, therefore it is advisable to display each signal period over 1div. by using **X MAG.x10**. For evaluation purposes, therefore, it is advisable to depict a signal period with X-MAG.-x10 over 10mm, or to work with software expansion x10.

The displayed trace height also has an effect on the quality of signal representation. For instance, a sine wave depicted with 10 samples per period can be less clearly recognized at a signal height of 8div. than with an amplitude of 2div. The function **DOT J.** can be used to interpolate between the dots. This improves waveform recognition.

If the sampling rate is too low aliasing will result (see figure below).

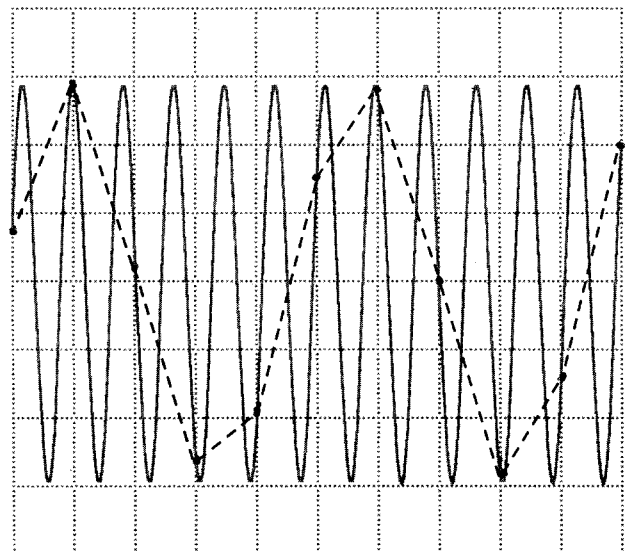

Operating Modes of the Y amplifiers

In principle, the HM 408 can work in digital storage mode with the same operating modes as in analog/real time mode. The following can therefore be displayed:

- Channel I single
- Channel II single
- Channels I and II simultaneously
- Sum of both channels
- Difference of both channels.
- XY-Mode

Deviations of the storage mode from the real time mode are:

- With the **DUAL** button depressed (simultaneous signal display of both channels) the facility for Chop mode does not exist. It is superfluous since the stored image does not flicker even at low frequencies. The two channels are scanned separately – but simultaneously. However, they are read out from the two single memories after one another (alternately) and displayed on the screen. Pressing the **CHOP** button has no effect.

Signals captured in **DUAL** mode must not be depicted in single-channel mode after storing them with HOLD, since the dot-joining function would then generate incorrect interpolations (envelopes). This also applies to the relevant passages in the documentation on the HAMEG interface.

Improper operation of this kind is indicated by a flashing channel display in the readout.

The storage time base is also active in XY storage mode.

HAMEG interface

The rear panel of the HM 408 contains a 26-pin connector which can be used to extract the data stored in memory. The data can either be accessed in digital form or converted to analog signals.

With the HAMEG Graphic Printer HM 8148-2, the digital data can be read out and documented as hardcopy. All readout data and cursor settings are also output to the Graphic Printer and printed out.

For data transfer to an IEEE-488 controller, the HAMEG IEEE-488 interface HO 79-2 can be connected. The RS-232C (V.24) interface HO 69 permits serial data transfer.

The XY/YT recorder interface HO 70 can also be used for documentation purposes.

Only one interface can be operated at a time. Before connecting a device or interface, the oscilloscope must be powered down. The interface is only active in storage mode.

Safety note

All connections of the interface are electrically connected with the storage module. Oscilloscopes belonging to Safety Class I with safety isolating transformer (Safety Class II) and oscilloscopes belonging to Safety Class II are connected with the grounded wire by way of the interface if Safety Class I devices are connected either directly or by way of the interface. As a result of this connection with the grounded wire, the oscilloscope is operated under Safety Class I conditions.

Measurements of high measurement reference potentials are therefore not possible, and run the risk of damaging the oscilloscope, the interface, and any connected devices.

If the safety instructions are not followed (see also "Safety" on page M 1), then any resulting damages to HAMEG products are excluded from the warranty. Nor does HAMEG assume any liability for injury to persons or damage to other makes of equipment.

Switching on and initial setting

Connect instrument to power outlet, depress red **POWER** button. LED indicates operating condition.

Case, chassis and all measuring terminals are connected to the safety earth conductor (Safety Class I).

Do not depress any further button. **TRIG.** selector switch to **AC**, **TV SEP.** switch unlocked.

LEVEL knob in **AT** position, **CH.I** input coupling switch to **GD**, set **TIME/DIV.** switch to **50 μ s/cm**.

Adjust **INTENS.** control for average brightness.

Center trace on screen using **X-POS.** and **Y-POS.I** controls. Then focus trace using **FOCUS** control.

Vertical amplifier mode

Channel I: All buttons in the Y section in out position.

Channel II: **CH.I/II** button depressed.

Channel I and II: **DUAL** button depressed. Alternate channel switching: **CHOP.** (**ADD**) button in out position.

Signals < 1 kHz or time coefficient ≥ 1 ms/cm: **CHOP.** button depressed.

Channel I+II (sum): depress only **ADD** button.

Channel I –II (difference): depress **ADD and INV. CH.II** button.

Triggering mode

Automatic Triggering: **Level** knob in **AT** position. Trace always visible.

Normal Triggering: **LEVEL** knob *not* in **AT** position. Trace visible when triggered.

Trigger edge direction: select with **SLOPE +/–** button.

Internal triggering: select channel with **TRIG. I/II(CH. I/II)** button.

External triggering: **EXT.** button depressed; sync. signal (0.2V_{pp} to 2V_{pp}) to **TRIG. INP.** socket.

Line triggering: **TRIG.** selector switch to \sim .

Select trigger coupling with **TRIG.** selector switch. Trigger frequency ranges:

AC: ≥ 10 Hz to 20 MHz; **DC:** DC to 20 MHz; **HF:** 15 kHz to 80 MHz; **LF:** DC to 1 kHz.

Composite video signal with line or horizontal frequency: **TV SEP.** switch locked. **TRIG.** selector HF(**H**).

Composite video signal with frame or vertical frequency: **TV SEP.** switch locked. **TRIG.** selector LF(**V**).

Select **SLOPE** switch to + (sync. pulse above) or – positions (sync. pulse below).

Pay attention to trigger indicator: LED above the **TRIG.** selector switch.

Storage mode

Mode selector switch: **STOR.** button.

STOR. LED lights continuously in storage mode.

Memory hold condition:

Channel I: **HOLD I** button depressed.

Channel II: **HOLD II** button depressed.

Channels I and II (DUAL): **HOLD I and HOLD II** buttons depressed.

Algebraic addition (ADD): **HOLD I** button depressed.

XY: **HOLD I or HOLD II** depressed.

Single sweep: first **SINGLE** button, after that **RESET** button depressed.

RESET LED lights at trigger readiness.

ROLL: **ms/s** button *and* **ROLL** depressed.

Measurements

Apply test signal to the vertical input connectors of **CH. I** and/or **CH. II**.

Before use, calibrate attenuator probe with built-in square wave generator **CAL.**

Switch input coupling to **AC** or **DC**.

Adjust signal to desired display height with attenuator switch.

Select time coefficient on the **TIME/DIV.** switch.

Incorrect time coefficient setting in storage mode is indicated by the flashing **STOR.** LED.

Set trigger point with **LEVEL** knob for Normal Triggering.

Trigger complex or aperiodic signals with longer **HOLD-OFF**-time.

Amplitude measurement with Y fine control at right stop (**CAL.**).

Time measurement with time fine control at right stop (**CAL.**).

Time expansion x10 with **X-MAG. x10** button depressed.

External horizontal sweep (**X-Y mode**) with **X-Y** button depressed (X input: **CH. II**).

READOUT display and measurements

Switch on **READOUT** and adjust readout brightness using **READOUT INTENS.**

Call up voltage measurement feature by pressing Δ U pushbutton.

Time period measurements can be performed by pressing Δ t.

For frequency measurements, press Δ U *and* Δ t together.

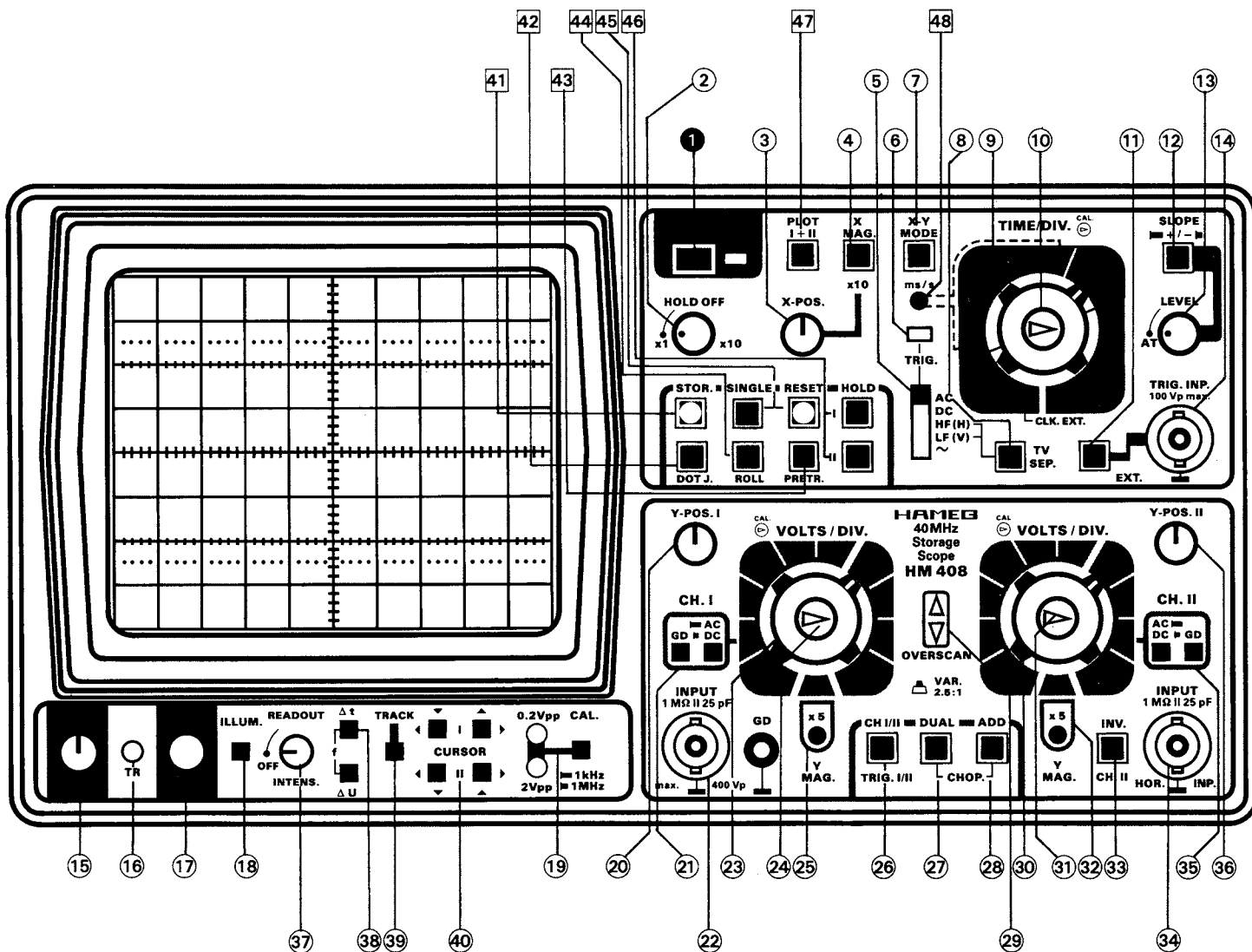

Elements for storage mode:

Element	Function	Element	Function
41 STOR. ON (pushbutton + LED)	Selects real time or storage mode. LED indicates storage mode. If time base range is wrong, LED is flashing.	45 SINGLE (pushbutton switch)	Single sweep operation.
42 DOT. J. (pushbutton switch)	Button depressed: connects sample points.	RESET (pushbutton + LED);	Arms oscilloscope for single sweep operation (indicated by LED). LED extinguishes after storage.
43 PRETR. (pushbutton)	Advances the start of the storage time base. The trigger point is shifted on the screen to the right in steps of 25%.	46 HOLD I / II (pushbutton switches)	HOLD I: Save memory CH. I. HOLD II: Save memory CH. II.
44 ROLL (pushbutton switch)	Selects ROLL mode when button ms/s (48) is depressed.	47 PLOT I+II (pushbutton)	Activates signal transfer for X-Y recorder or RS 232 mode.
		48 ms/s (pushbutton switch)	Time coefficients (framed by the dashed line) are extended 1000-fold. In combination with 44 "roll mode" is possible.

Front Panel Elements HM 408 (Brief Description – Front View)

Element	Function	Element	Function
① POWER on/off (pushbutton + LED)	Turns scope on and off. LED indicates operating condition.	②② INPUT (CH. I) (BNC-connector) (4 mm socket)	CH. I signal input. Input impedance 1MΩ 25 pF. Separate ground jack.
② HOLD OFF (knob)	Controls holdoff time between sweeps. Normal position = fully ccw.	②③ VOLTS/DIV. (rotary switch)	CH. I input attenuator. Selects input sensitivity in mV/div or V/div in 1-2-5 sequence.
③ X-POS. (knob)	Controls horizontal position of trace. (Not in X-Y storage mode).	②④ VAR. GAIN (center knob)	Continuously variable gain between the calibrated settings of the VOLTS/DIV switch. Decreases sensitivity 1: 2.5. Cal. position: cw.
④ X-MAG. x10 (pushbutton switch)	10 fold expansion in X direction. When depressed, max. resolution = 5 ns/div.	②⑤ Y MAG. x5 (pushbutton switch)	When depressed, increasing of Y-sensitivity 5 fold (max. 1 mV/div).
⑤ TRIG. AC-DC-HF-LF-~ (lever switch)	Trigger selector AC: 10 Hz – 20 MHz. DC: 0 – 20 MHz. HF: 15 kHz – 80 MHz. LF: 0 – 1 kHz. ~: Internal line triggering.	②⑥ CH I/II-TRIG. I/II (pushbutton switch)	Button released: CH. I only and internal triggering from CH. I. Button depressed: CH. II only and internal trig. from CH. II. In DUAL and ADD mode: Button selects internal trigger signal.
⑥ TRIG. (LED)	LED lights, if sweep is triggered.	②⑦ DUAL (pushbutton switch)	 <p>Button released: One channel only. Button depressed: CH. I and CH. II in alternate mode. DUAL and ADD buttons depressed: CH. I and CH. II in chopped mode.</p>
⑦ X-Y (pushbutton switch)	Selects X-Y operation, stops sweep. X signal via CH. II. Attention! Phosphor burn-in without X signal.	②⑧ ADD (pushbutton switch)	
⑧ TV SEP. (pushbutton switch)	TV Sync. Separator. TRIG (⑤) in position HF (H) = triggering of line frequency, position LF (V) = triggering of frame frequency.	②⑨ OVERSCAN (LED indicators)	Direction indicators. Illuminated when trace passes vertical screen limits.
⑨ TIME/DIV. (rotary switch)	Selects time coefficients (speeds) real time: from 0.05 μs/div. to 1 s/div, storage mode: from 10 μs/div to 50 s/div.	③① VOLTS/DIV. (rotary switch)	CH. II input attenuator. Selects input sensitivity in mV/div or V/div in 1-2-5 sequence.
⑩ Variable (center knob)	Timebase variable control. Decreases timebase sweep speed 1: 2.5 (real time only). Cal. position = full clockwise.	③② VAR. GAIN (center knob)	Continuously variable gain for CH. II. Specifications like ②④.
⑪ EXT. (pushbutton switch)	Button released = internal triggering. Button depressed = external triggering, trigger signal via TRIG. INP. ⑭.	③③ Y MAG. x5 (pushbutton switch)	When depressed, increasing of Y-sensitivity 5 fold (max. 1 mV/div).
⑫ SLOPE +/- (pushbutton switch)	Selects the slope of the trigger signal. + = rising edge; - = falling edge.	③④ INV. CH II (pushbutton switch)	Inversion of CH. II display. In combination with ADD button ②⑧ = algebraic addition.
⑬ LEVEL (knob)	Adjustment of trigger level in normal triggering mode; when in AT position (ccw) = automatic triggering.	③⑤ INPUT CH. II (BNC-connector)	CH. II signal input and input for horizontal deflection in X-Y mode.
⑭ TRIG. INP. (BNC connector)	Input for external trigger signal, if button ⑪ is depressed.	③⑥ AC-DC-GD (pushbutton switches)	Selects input coupling of the CH. II Vertical Amplifier. (See ②①).
⑮ INTENS. (knob)	Intensity control for trace brightness.	③⑦ Y-POS. II (knob)	Controls vertical position of CH. II display. In analog X-Y mode inoperative.
⑯ TR (pot)	Trace rotation. To align trace with horizontal graticule line. Compensates influence of earth's magnetic field.	READOUT:	
⑰ FOCUS (knob)	Focus control for trace sharpness.	③⑧ INTENS. (knob)	Adjustment of Readout Intensity. In OFF position (ccw) no display.
⑱ ILLUM. (pushbutton)	Scale illumination On/Off.	③⑨ Δt/ΔU/f (pushbuttons)	Activates cursor functions. Δt depressed: period measurements. ΔU depressed: voltage measurements. Δt and ΔU depressed: frequency measurement.
⑲ 0.2V-2V (test sockets)	Calibrator square wave output, 0.2 V _{pp} or 2 V _{pp} resp.	④① TRACK (pushbutton)	When depressed simultaneous control of both cursors with CURSOR I buttons.
CAL. 1kHz/1MHz (pushbutton switch)	Selects calibrator frequency. Button not depressed: approx. 1 kHz; button depressed: approx. 1 MHz.	④② CURSOR (pushbuttons)	Pushbuttons for CURSOR control. Dependent on selected measuring function, movement in horizontal or vertical direction.
⑳ Y-POS. I (knob)	Controls vertical position of CH. I display.		
㉑ GD-AC-DC (pushbutton switches)	Selects input coupling of the CH. I Vertical Amplifier. AC/DC depressed: direct coupling; AC/DC released: Signal is capacitively coupled (DC is blocked). GD depressed: Signal is disconnected, amplifier input is grounded.		

Test Instructions

General

These Test Instructions are intended as an aid for checking the most important characteristics of the HM408 at regular intervals without the need for expensive test equipment.

As with the First Time Operation Instructions, care should be taken that all knobs with arrows are set to their calibrated positions. None of the pushbuttons should be depressed.

TRIG. selector switch to **AC**. It is recommended to switch on the instrument for about 15 minutes prior to the commencement of any check.

Cathode-Ray Tube: Brightness and Focus, Linearity, Raster Distortions

Normally, the CRT of the HM408 has very good brightness. Any reduction of this brightness can only be judged visually *in the real time mode*. However, decreased brightness may be the result of reduced high voltage. The latter is easily recognized by the greatly increased sensitivity of the vertical amplifier. The control range for maximum and minimum brightness (intensity) must be such that the beam just disappears before reaching the left hand stop of the **INTENS.** control (particularly when the **X-Y** button is depressed), while with the control at the right hand stop the focus and the line width are just acceptable.

With maximum intensity the timebase fly-back must on no account be visible. Visible trace fault without input signal: bright dot on the left side – *or* – decreasing brightness from left to right or shortening of the baseline. (Cause: Incorrect Unblanking Pulse.) It should be noted that with wide variations in brightness, refocusing is always necessary. Moreover, with maximum brightness, no “pumping” of the display must occur. If pumping does occur, it is normally due to a fault in the regulation circuitry for the high voltage supply.

A certain out-of-focus condition in the edge zone of the screen must be accepted. It is limited by standards of the CRT manufacturer. The same is valid for tolerances of the orthogonality, the undeflected spot position, the non-linearity and the raster distortion in the marginal zone of the screen in accordance with international standards (see CRT data book). These limit values are strictly supervised by HAMEG. The selection of a cathode-ray tube without any tolerances is practically impossible.

Astigmatism Check

Check whether the horizontal and vertical sharpness of the display are equal. This is best seen by displaying a square-wave signal with the repetition rate of approximately 1 MHz. Focus the horizontal tops of the square-wave signal at normal intensity, then check the sharpness of the vertical edges. A certain loss of marginal sharpness of the CRT is unavoidable; this is due to the manufacturing process of the CRT.

Symmetry and Drift of the Vertical Amplifier

Both of these characteristics are substantially determined by the input stages of the amplifiers.

The symmetry of channel II and the vertical final amplifier can be checked by inverting Channel II (depress the **INV. CHII** pushbutton). The vertical position of the trace should not change by more than 0.5 div. However, a change of 1 div. is just permissible. Larger deviations indicate that changes have occurred in the amplifier.

A further check of the vertical amplifier symmetry is possible by checking the control range of the **Y-POS.** controls. A sine-wave signal of 10-100kHz is applied to the amplifier input. When the **Y-POS.** control is then turned fully in both directions from stop to stop with a display height of approximately **8 div.**, the upper and lower positions of the trace that are visible should be approximately of the same height. Differences of up to 1 div. are permissible (input coupling should be set to **AC**).

Checking the drift is relatively simple. **Ten minutes after switching on the instrument**, set the baseline exactly on the horizontal center line of the graticule. The beam position must not change by more than **0.5 div.** during the following hour.

Calibration of the Vertical Amplifier

Two square-wave voltages of **0.2V_{pp}** and **2V_{pp} ± 1%** are present at the output eyelets of the calibrator (**CAL.**). If a direct connection is made between the **0.2V** output and the input of the vertical amplifier (e.g. using a **x1 probe**), the displayed signal in the **50mV/div.** position (variable control to **CAL.**) should be **4 div.** high (**DC** input coupling). Maximum deviations of 0.16 div. (4%) are permissible. If a **x10 probe** is connected between the **2V** output socket and Y input, the same display height should result. With higher tolerances it should first be investigated whether the cause lies, within the amplifier or in the amplitude of the square-wave signal. On occasions it is possible that the probe is faulty or incorrectly compensated. If necessary the measuring amplifier can be calibrated with an accurately known DC voltage (**DC** input coupling). The trace position should then vary in accordance with the deflection coefficient set.

With variable control at the attenuator switch fully counter-clockwise, the input sensitivity is decreased at least by the factor 2.5 in each position. In the **50mV/div.** position, the displayed calibrator signal height should vary from 4 div. to at least 1.6 div.

Transmission Performance of the Vertical Amplifier

The transient response and the delay distortion correction can only be checked with the aid of a square-wave generator with a fast risetime (**max. 5ns**). The signal coaxial cable (e.g. HZ34) must be terminated at the vertical input of the oscilloscope with a resistor equal to the characteristic impedance of the cable (e.g. with HZ22). Checks should be made at 100Hz, 1kHz, 10kHz, 100kHz and 1MHz, the deflection coefficient should be set at **5mV/div.** with **DC** input coupling (Y variable control in **CAL.** position). In so

doing, the square pulses must have a flat top without ramp-off, spikes and glitches; no overshoot is permitted, especially at 1 MHz and a display height of **4-5 div.** At the same time, the leading top corner of the pulse must not be rounded. In general, no great changes occur after the instrument has left the factory, and it is left to the operator's discretion whether this test is undertaken or not. A suited generator for this test is the HZ60 from HAMEG.

Of course, the quality of the transmission performance is not only dependent on the vertical amplifier. **The input attenuators**, located in the front of the amplifier, **are frequency-compensated in each position.** Even small capacitive changes can reduce the transmission performance. Faults of this kind are as a rule most easily detected with a square-wave signal with a low repetition rate (e.g. 1 kHz). If a suitable generator with max. output of $10V_{pp}$ is available, it is advisable to check at regular intervals the deflection coefficients on all positions of the input attenuators and readjust them as necessary. A compensated **2:1 series attenuator** (e.g. HZ23) is also necessary, and this must be matched to the input impedance of the oscilloscope. This attenuator can be made up locally. It is important that this attenuator is shielded. For local manufacture, the electrical components required are a $1 M\Omega \pm 1\%$ resistor and, in parallel with it, a trimmer 3-15 pF in parallel with approx. 20 pF. One side of this parallel circuit is connected directly to the input connector of CH.I or CH.II and the other side is connected to the generator, if possible via a low-capacitance coaxial cable. The series attenuator must be matched to the input impedance of the oscilloscope in the **5 mV/div.** position (variable control to **CAL.**, **DC** input coupling; square tops exactly horizontal; no ramp-off is permitted). This is achieved by adjusting the trimmer located in the 2:1 attenuator. **The shape of the square-wave should then be the same in each input attenuator position.**

Operating Modes: CH.I/II, DUAL, ADD, CHOP., INVERT and X-Y Operation

On depressing the **DUAL** pushbutton, two traces must appear immediately. When one trace is shifted vertically across the entire screen, the position of the other trace must not vary by more than 0.05 div.

A criterion in chopped operation is trace widening and shadowing around and within the two traces in the upper or lower region of the screen. Set **TIME/DIV.** switch to **2 μ s/div.**, depress the **DUAL** and **CHOP.** pushbutton, set input coupling of both channels to **GD** and advance the **INTENS.** control fully clockwise. Adjust **FOCUS** for a sharp display. With the **Y-POS.** controls shift one of the traces to a +2 div., the other to a -2 div. vertical position from the horizontal center line of the graticule. Do not try to synchronize (with the time variable control) the chop frequency (0.5 MHz)! Then alternately release and depress the **CHOP.** pushbutton. Check for negligible trace widening and periodic shadowing in the chopped mode.

It is important to note that in the **I+II** add mode (only **ADD** depressed) or the **+I-II** difference mode (**INV. CHII** button depressed in addition) the vertical position of the trace can be adjusted by using **both** the Channel I and Channel II **Y-POS.** controls.

In X-Y Operation (**X-Y** pushbutton depressed), the sensitivity in both deflection directions will be the same. When the signal from the built-in square-wave generator is applied to the input of Channel II, then, as with Channel I in the vertical direction, there must be a horizontal deflection of **4 div.** when the deflection coefficient is set to **50 mV/div.** position (variable control set to its **CAL.** position). The check of the mono channel display with the **CHI/II** button is unnecessary; it is contained indirectly in the tests above stated.

Triggering Checks

The internal trigger threshold is important as it determines the display height from which a signal will be stably displayed. It should be approx. 0.3-0.5 div. for the HM408. An increased trigger sensitivity creates the risk of response to the noise level in the trigger circuit, especially when the sensitivity of the vertical input is increased by pressing **Y-MAG.x5** button. This can produce double-triggering with two out-of-phase traces. Alteration of the trigger threshold is only possible internally. Checks can be made with any **sine-wave voltage** between 50 Hz and 1 MHz. The **LEVEL** knob should be in **AT** position (**Automatic Triggering**). Following this it should be ascertained whether the same trigger sensitivity is also present with Normal Triggering. In this trigger mode, a **LEVEL** adjustment is necessary. The checks should show the same trigger threshold with the same frequency. On depressing the **+/-** slope button, the start of the sweep changes from the positive-going to the negative-going edge of the trigger signal. As described in the Operating Instructions, the trigger frequency range is dependent on the trigger coupling selected. For higher frequencies the **HF** coupling mode must be selected. In this mode, triggering up to at least 80 MHz (sine-wave) is possible. Internally the HM408 should trigger perfectly at a display height of approx. 0.5 div., when the appropriate trigger coupling mode is set.

For external triggering (**EXT.** button depressed), the **EXT. TRIG.** input connector requires a signal voltage of at least **0.2 V_{pp}**, which is in synchronism with the Y input signal. The voltage value is dependent on the frequency and the trigger coupling mode (**AC-DC-HF-LF**).

Checking of the TV triggering is possible with a video signal of any given polarity. Lock the **TV SEP.** pushbutton (in). Use the **HF (H)** positions of the trigger selector switch **TRIG.** switch for triggering on **line** or horizontal frequency (**TIME/DIV.** switch to 20 or 10 μ s/div). The **LF (V)** positions is required for **frame** or vertical frequency (**TIME/DIV.** switch to 5 or 2 ms/div). The **+** and **-** positions at **SLOPE** must correspond to the sync pulse.

Perfect TV triggering is achieved, when in both display modes the amplitude of the complete TV signal (from white level to the top of the line sync pulse) is limited between 0.8 and 8 div.

The display should not shift horizontally during a change of the trigger coupling from **AC** to **DC** with a **sine-wave signal without DC offset**.

If both vertical inputs are **AC** coupled to the same signal and both traces are brought to coincide exactly on the screen, when working in the **alternate dual channel mode**, then no change in display should be noticeable when the **CH.I/II-TRIG.I/II** button is depressed or released or when the **TRIG.** selector switch is changed from **AC** to **DC** position.

Checking of the line/mains frequency triggering (50-60 Hz) is possible, when the input signal is time-related (multiple or submultiple) to the power line frequency (**TRIG.** selector switch to \sim). There is no trigger threshold in this trigger mode. Even very small input signals are triggered stably (e.g. ripple voltage). For this check, use an input of approx. 1 V. The displayed signal height can then be varied by turning the respective input attenuator switch and its variable control.

Timebase

Before checking the timebase it should be ascertained that the **trace length is approx. 10.2 div. in all time ranges**.

If a precise marker signal is not available for checking the **Timebase time coefficients**, then an accurate sine-wave generator may be used. Its frequency tolerance should not be greater than $\pm 1\%$. The timebase accuracy of the HM 408 is given as $\pm 3\%$, but as a rule it is considerably better than this. For the simultaneous checking of timebase linearity and accuracy at least 10 oscillations, i.e. **1 cycle every div.**, should always be displayed. For precise determination, set the peak of the first marker or cycle peak exactly behind the first vertical graticule line using the **X-POS.** control. Deviation tendencies can be noted after some of the marker or cycle peaks.

The **20** and **10 ms/div.** ranges of the **TIME/DIV.** switch can be checked very precisely with line frequency (**50 Hz only**). On the **20 ms/div.** range a cycle will be displayed every div., while on the **10 ms/div.** range it will be every 2 div.

If a precise Time Mark Generator is used for checking, Normal Triggering (**LEVEL** knob not in **AT** position) and **LEVEL** control adjustment is recommended.

The following table shows which frequencies are required for the particular ranges.

Real time ranges	Storage ranges
	5 s/cm – 0.2 Hz
	2 s/cm – 0.5 Hz
1 s/cm – 1 Hz	1 s/cm – 1 Hz
0.5 s/cm – 2 Hz	0.5 s/cm – 2 Hz
0.2 s/cm – 5 Hz	0.2 s/cm – 5 Hz
0.1 s/cm – 10 Hz	0.1 s/cm – 10 Hz
50 ms/cm – 20 Hz	50 ms/cm – 20 Hz
20 ms/cm – 50 Hz	20 ms/cm – 50 Hz
10 ms/cm – 100 Hz	10 ms/cm – 100 Hz
5 ms/cm – 200 Hz	5 ms/cm – 200 Hz
2 ms/cm – 500 Hz	2 ms/cm – 500 Hz
1 ms/cm – 1 kHz	1 ms/cm – 1 kHz
0.5 ms/cm – 2 kHz	0.5 ms/cm – 2 kHz
0.2 ms/cm – 5 kHz	0.2 ms/cm – 5 kHz
0.1 ms/cm – 10 kHz	0.1 ms/cm – 10 kHz
50 μ s/cm – 20 kHz	50 μ s/cm – 20 kHz
20 μ s/cm – 50 kHz	20 μ s/cm – 50 kHz
10 μ s/cm – 100 kHz	10 μ s/cm – 100 kHz
5 μ s/cm – 200 kHz	
2 μ s/cm – 500 kHz	
1 μ s/cm – 1 MHz	
0.5 μ s/cm – 2 MHz	
0.2 μ s/cm – 5 MHz	
0.1 μ s/cm – 10 MHz	
0.05 μ s/cm – 20 MHz	

The **time variable control** range can be checked in the analog mode only. The sweep speed becomes slower by turning this variable control counter-clockwise to its left stop.

When the **X-MAG. x10** button is depressed, a marker or cycle peak will be displayed every 10 div. $\pm 5\%$ (with variable control in **CAL.** position; measurement in the **5 μ s/div.** range). The tolerance is better measurable in the **50 μ s/div.** range (one cycle every 1 div).

Trace Alignment

The CRT has an admissible angular deviation $\pm 5^\circ$ between the X deflection plane D1-D2 and the horizontal center line of the internal graticule. This deviation, due to tube production tolerances (and only important after changing the CRT), and also the influence of the earth's magnetic field, which is dependent on the instrument's North orientation, are corrected by means of the **TR** potentiometer. In general, the trace rotation range is asymmetric. It should be checked, whether the baseline can be adjusted somewhat sloping **to both sides** round about the horizontal center line of the graticule. With the HM 408 in its closed case, an angle of rotation $\pm 0.57^\circ$ (0.1 div. difference in elevation per 10 div. graticule length) is sufficient for the compensation of the earth's magnetic field.

Service Instructions

General remarks

We recommend that the oscilloscope never be opened or any work done on its internal components.

If this is unavoidable, however, then it is essential to observe the following **safety information and warnings**.

If your oscilloscope should develop a defect, please have any necessary repairs carried out by HAMEG. Send equipment for repair to HAMEG packaged in its original box, and attach a written description of the problem (see warranty on M2).

For technical information, please call your nearest HAMEG Customer Service or Representative.

SAFETY NOTES

1. When opened, this equipment may only be powered by a Class II safety isolating transformer.
2. The equipment grounding conductor between the power connector and the chassis of the oscilloscope must not be interrupted.

Instrument Case Removal

The rear cover can be taken off after unplugging the power cord's triple-contact connector and after two cross recessed pan head screws (M4x30mm) with two washers on it have been removed. While the instrument case is firmly held, the entire chassis with its front panel can be withdrawn forward. When the chassis is inserted into the case later on, it should be noticed that the case has to fit under the flange of the front panel. The same applies for the rear of the case, on which the rear cover is put.

Caution

During opening or closing of the case, the instrument must be disconnected from all power sources for maintenance work or a change of parts or components. If a measurement, trouble-shooting, or an adjustment is unavoidable, this work must be done by a specialist, who is familiar with the risk involved.

When the instrument is set into operation after the case has been removed, attention must be paid to the accel-

eration voltage for the CRT – 14 kV – and to the operating voltages for both final amplifier stages – approx. 115 V. Potentials of these voltages are on the CRT socket, on the upper and the lower horizontal PCBs, and on the lateral PCB directly beside the CRT neck. High voltages of max. 2000 V are also at the INTENS. and FOCUS potentiometers (lower left corner on the rear of the front chassis). Such potentials are moreover on the checkpoint strips on the upper and the lower PCB (7- and 5-pole). They are highly dangerous and therefore precautions must be taken. It should be noted furthermore that shorts occurring on different points of the CRT high voltage and unblanking circuitry will definitely damage some semiconductors. For the same reason it is very risky to connect capacitors to these points while the instrument is on.

Capacitors in the instrument may still be charged, even when the instrument is disconnected from all voltage sources. Normally, the capacitors are discharged 6 seconds after switching off. However, with a defective instrument an interruption of the load is not impossible. Therefore, after switching off, it is recommended to connect one by one all terminals of the check strips on the upper and the lower PCBs across 1 k Ω to ground (chassis) for a period of 1 second.

Handling of the CRT needs utmost caution. The glass bulb must not be allowed – under any circumstances – to come into contact with hardened tools, nor should it undergo local superheating (e.g. by soldering iron) or local undercooling (e.g. by cryogenic-spray). We recommend the wearing of safety goggles (implosion danger).

Operating Voltages

Besides the two AC voltages for the CRT heating (6.3V) and 12V for graticule illumination and line triggering, there are eight electronically regulated DC operating voltages generated (+12V, +5V, –12V, –5V, +115V, +55V, –2000V, and 12kV post accelerating voltage). These different operating voltages are fixed voltages, except the +12V which can be adjusted. The variation of the fixed voltages greater than $\pm 2\%$ from the nominal value indicates a fault. These voltages are measured on the checkpoint strip with reference to ground (see Adjusting Plan). Measurements of the high voltage may only be accomplished by the use of a sufficient highly resistive voltmeter ($>10\text{M}\Omega$). You must make absolutely sure that the electric strength of the voltmeter is sufficiently high.

HAMEG[®]

Instruments

Oscilloscopes
Multimeters
Counters
Frequency
Synthesizers
Generators
R- and LC-
Meters
Spectrum
Analyzers
Power Supplies
Curve Tracers
Time Standards

Germany

HAMEG GmbH

Kelsterbacher Str. 15-19
60528 FRANKFURT am Main
Tel. (069) 67805-0
Telefax (069) 6780513

France

HAMEG S.a.r.l

5-9, av. de la République
94800-VILLEJUIF
Tél. (1) 4677 8151
Telefax (1) 4726 3544

Spain

HAMEG S.L.

Villarroel 172-174
08036 BARCELONA
Teléf. (9) 3 4301597
Telefax (9) 3 3212201

Great Britain

HAMEG LTD

74-78 Collingdon Street
LUTON Bedfordshire LU1 1RX
Phone (0582) 413174
Telefax (0582) 456416

United States of America

HAMEG, Inc.

1939 Plaza Real
OCEANSIDE, CA 92056
Phone (619) 630 4080
Telefax (619) 630 6507

HAMEG, Inc.

266 East Meadow Avenue
EAST MEADOW, NY 11554
Phone (516) 794 4080
Toll-free (800) 247 1241
Telefax (516) 794 1855

Hong Kong

HAMEG LTD

Flat 1, 4/F.
Crown Industrial Building
106 How Ming St., Kwun Tong
Kowloon, Hong Kong
Phone (852) 2 793 0218
Telefax (852) 2 763 5236